

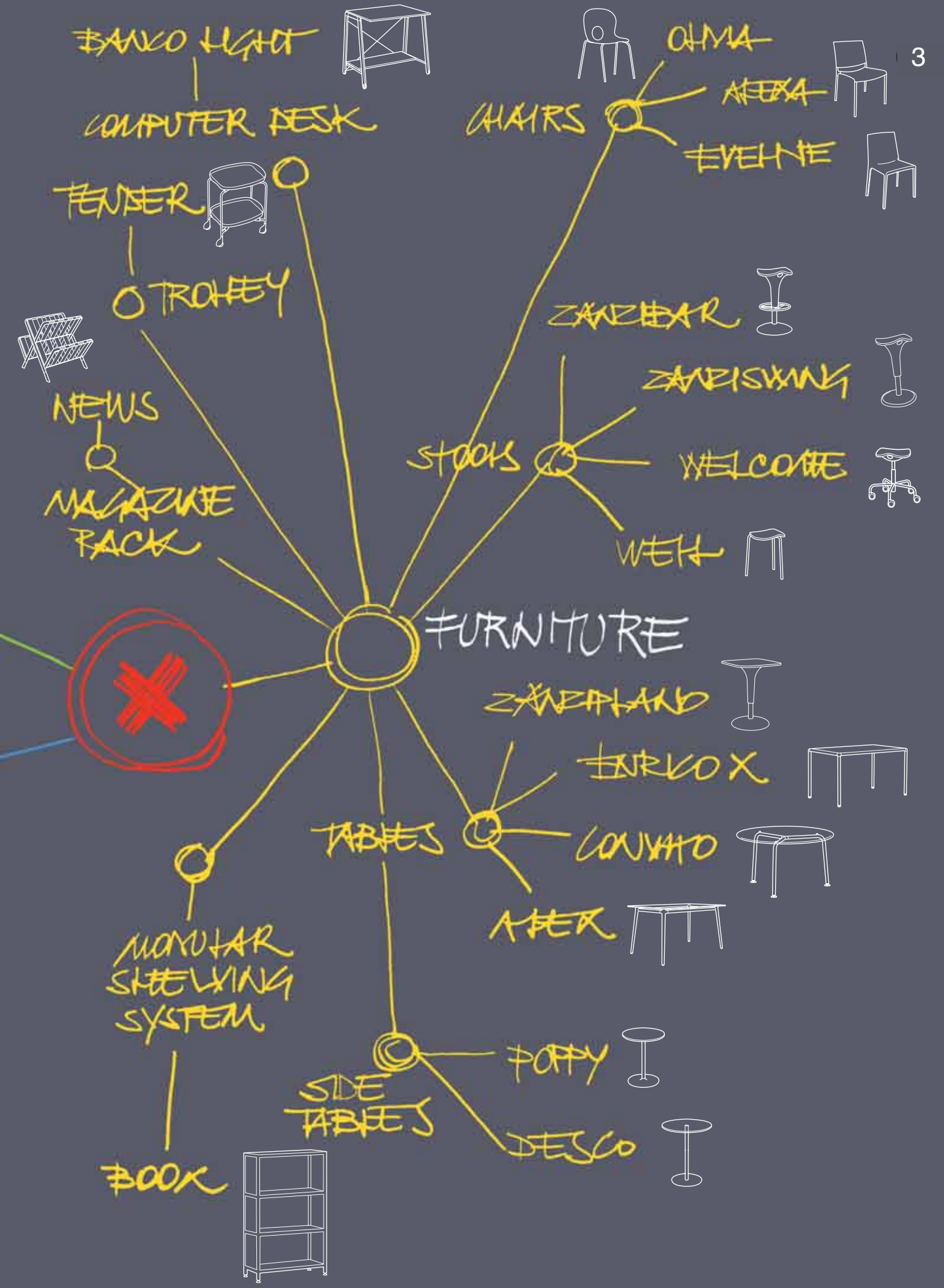

CATALOGO

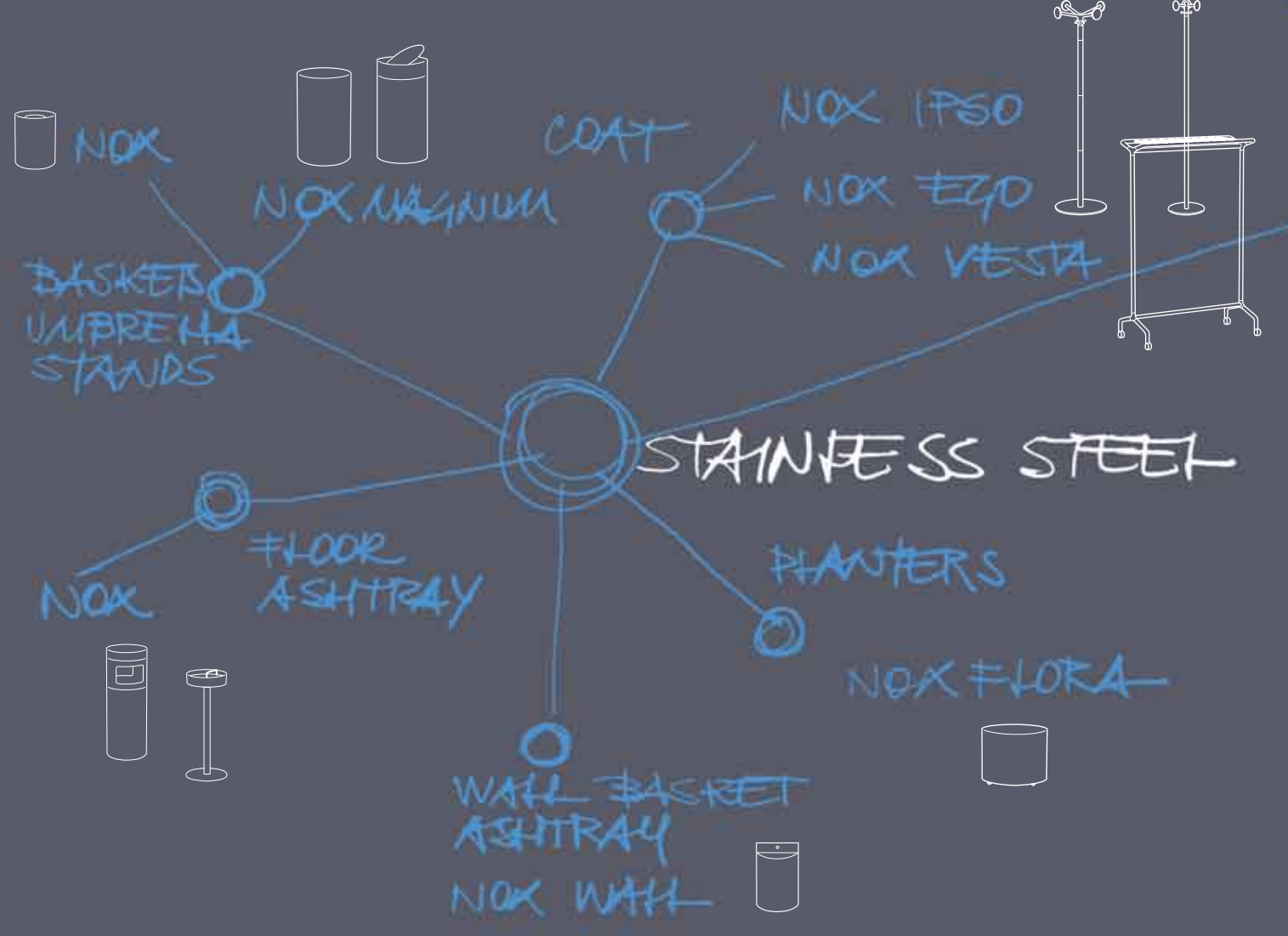



Semplici ma non banali, originali ma non bizzarri.

Una filosofia ispiratrice mantenuta con coerenza attraverso gli anni, che ha consentito la creazione di prodotti dimostratisi degli autentici classici senza tempo, anche se fedeli interpreti della continua evoluzione della realtà e delle nuove tendenze. Le collezioni Rexite, destinate ai più svariati ambiti del mondo della Casa, dell'Ufficio e del Contract, si distinguono per il design rigoroso, l'alta qualità dei materiali e le tecnologie rispettose dell'ambiente.

Simple yet not ordinary, original but not bizarre.

Constantly evolving timeless classics able to interpret reality and new trends: the output of an inspiring philosophy which has kept coherent over the years. Rexite collections, created for the most diverse Home, Office and Contract contexts, stand out thanks to rigorous design, high quality materials and eco-friendly technology.

Simple, mais pas banals, originaux mais pas bizarres

Une philosophie inspiratrice conservée avec cohérence le long des années, qu'elle a permis de créer des produits qui se sont avérés des authentiques classiques sans temps, tout en restant de fidèles interprètes de l'évolution continue de la réalité et des nouvelles tendances. Les collections Rexite, destinées aux domaines les plus variés de la Maison, du Bureau et du Contract, ressortent pour le dessin rigoureux, la haute qualité des matières et des technologies vouées au respect de l'environnement.

Schlicht, jedoch nicht banal, originell, edoch nicht bizarr.

Eine anregende Philosophie, die mit Konsequenz im Laufe der Jahre beibehalten wurde, gab die Möglichkeit Produkte zu schaffen, die sich mit der Zeit authentisch und klassisch bewiesen haben, obwohl sie der ständigen Evolution der Realität und der neuen Tendenzen folgen. Die Rexite Kollektionen, die für die unterschiedlichen Bereiche der Wohnung, des Büros und des Contract bestimmt sind, zeichnen sich durch ihr präzises Design, durch die hohe Qualität der eingesetzten Materialien und der umweltfreundlichen Technologie aus.

Simple pero no banal, original pero no extravagante.

Una filosofía inspiradora mantenida con coherencia a lo largo de los años, que ha permitido crear productos que han demostrado ser clásicos sin tiempo, aunque fieles intérpretes de la continua evolución de la realidad y de las nuevas tendencias. Las colecciones Rexite, destinadas a los ámbitos más diversos del mundo de la Casa, de la Oficina y del Contract, se distinguen por su diseño riguroso, por la alta calidad de los materiales y por las tecnologías utilizadas que respetan el medio ambiente.



EUROPEAN DESIGN PRIZE
Innovation and design in Europe

1997 PARIS

BIBLIO	12° Compasso d'Oro	1981 MILANO
	14° SMAU Industrial Design	1981 MILANO
	10° Biennial of Industrial Design	1984 LJUBLJANA
BIRILLO	17° SMAU Industrial Design	1984 MILANO
CRIBBIO	17° SMAU Industrial Design	1984 MILANO
	XVII Premio Nazionale arti visive	1993 GALLARATE
APPRENDISTA	Forum Design	1987 MILANO
	12° Biennial of Industrial Design	1988 LJUBLJANA
SALTIMBANCO	Forum Design	1987 MILANO
	Design for Europe	1988 KORTRIJK
	12° Biennial of Industrial Design	1988 LJUBLJANA
	Design Plus	1989 FRANKFURT
CONTRATTEMPO	15° Compasso d'Oro	1989 MILANO
	12° Biennial of Industrial Design	1988 LJUBLJANA
	Design Plus	1988 FRANKFURT
FRITZ	Design for Europe	1988 KORTRIJK
	Forum Design	1989 MILANO
STATUS	Forum Office Design	1989 MILANO
	Form '90	1990 FRANKFURT
	Forum Office Design	1991 MILANO
MODUS	16° Compasso d'Oro	1991 MILANO
	Design Plus	1992 FRANKFURT
	Industrie Forum Design	1992 HANNOVER
	ADI Techhotel	1992 GENOVA
	XVII Premio Nazionale Arti Visive	1993 GALLARATE
	Design Plus	1992 FRANKFURT
	Design Center Stuttgart	1992 STUTTGART
	Form '92	1992 FRANKFURT
DOPPIOPETTO	ADI Techhotel	1992 GENOVA
	Neste Forma Finlandia 3	1993 ESPOO
	Form '93	1993 FRANKFURT
PAPARAZZO	Design Plus	1993 FRANKFURT
	Neste Forma Finlandia 3	1993 ESPOO
VERCINGETORIGE	Design Plus	1994 FRANKFURT
	I.D. Magazine	1994 NEW YORK
	Minerva Design Awards	1995 LONDON
	International Gift Show	1995 TOKYO
ECO	Form '94	1994 FRANKFURT
APPUNTAMENTO	Form '95	1995 FRANKFURT
ATTILA	BBC Design Awards	1996 LONDON
	The Chicago Athenaeum	1996 CHICAGO
	Accent on Design	1997 NEW YORK
	I.D. Magazine	1997 NEW YORK
	Design Center Stuttgart	1997 STUTTGART

CACTUS

The Chicago Athenaeum 1997 CHICAGO

BANCO

The Chicago Athenaeum 1997 CHICAGO

HANNIBAL

I.D. Magazine 1998 NEW YORK

Time Magazine 1998 NEW YORK

Design Center Stuttgart 1998 STUTTGART

The Chicago Athenaeum 1998 CHICAGO

National Stationery Show 1998 NEW YORK

Form '99 1999 FRANKFURT

ISIS

National Stationery Show 1999 NEW YORK

The Chicago Athenaeum 1999 CHICAGO

Form 2000 2000 FRANKFURT

I.D. Magazine 2000 NEW YORK

TENDER

The Chicago Athenaeum 1999 CHICAGO

ADI Design Index 98 2000 MILANO

ECO PRO

ADI Design Index 99 2000 MILANO

BANCO PLUS

18° Compasso d'Oro 1998 MILANO

Premio A.M.I. 1998 LUZERN

Workspheres (MoMA) 2001 NEW YORK

CD2

The Chicago Athenaeum 2000 CHICAGO

Form 2001 2001 FRANKFURT

19° Compasso d' Oro 2001 MILANO

GAS

19° Compasso d' Oro 2001 MILANO

BABELE

Workspheres (MoMA) 2001 NEW YORK

BREAKFAST

Form 2001 2001 FRANKFURT

Design Center Stuttgart 2001 STUTTGART

BANCO GLASS

Neocon 2001 Best of Show I.D. Magazine 2001 CHICAGO

2002 NEW YORK

ZANZIBAR

Neocon 2001 Best of Show 2001 CHICAGO

18° Biennial of Industrial Design 2002 LJUBLJANA

Catas 2002 2002 UDINE

FX International Interior Design 2003 LONDON

The Chicago Athenaeum 2003 CHICAGO

NOX

Contract Design 2002 GENOVA

ZANZI SWING

RED DOT 2003 ESSEN

I.D. Magazine 2003 NEW YORK

Rat für Formgebung 2004 FRANKFURT

ZANZIPLANO

I.D. Magazine 2003 NEW YORK

WELCOME

The Chicago Athenaeum 2003 CHICAGO

19° Biennial of Industrial Design 2004 LJUBLJANA

NOX MAGNUM

Architektur und Office 2004 KOELN

19° Biennial of Industrial Design 2004 LJUBLJANA

WELL

19° Biennial of Industrial Design 2004 LJUBLJANA

OLIVIA

The Chicago Athenaeum 2004 CHICAGO

FX International Interior Design 2004 LONDON

19° Biennial of Industrial Design 2004 LJUBLJANA

Grandesign 2005 MILANO

Interior Innovation 2006 KOELN

CONVITO

Interior Innovation 2006 KOELN

The Chicago Athenaeum 2006 CHICAGO

BOOX

20° Biennial of Industrial Design 2006 LJUBLJANA

The Chicago Athenaeum 2007 CHICAGO

Rat Für Formgebung 2008 FRANKFURT

ALEXA

21° Biennial of Industrial Design 2008 LJUBLJANA

TABOO

ADI Design Index 09 2010 MILANO



		PAGE
SEDUTE CHAIRS	OLIVIA ALEXA EVELINE	10 / 27 28 / 39 40 / 51
SGABELLI STOOLS	ZANZIBAR ZANZI SWING WELCOME WELL	54 / 59 60 / 61 62 / 63 64 / 67
TAVOLI TABLES	ZANZIPLANO ENRICO X CONVITO ALEX	70 / 77 78 / 81 82 / 87 88 / 93
TAVOLINI SIDE TABLES	POPPY DESCO	94 / 97 98 / 99
SCRITTOI PER COMPUTER COMPUTER DESK	BANCO LIGHT	102 / 103
CARRELLI/VASSOI TROLLEY/TRAY	TENDER	104 / 105
PORTARIVISTE MAGAZINE RACK	NEWS	106 / 107
SISTEMI CONTENITORI MODULARI MODULAR SHELVING SYSTEM	BOOX	110 / 123
APPENDIABITI COAT	CACTUS POP DOPPIOPETTO AIUTO UNPOSTO- DUEPOSTI- TREPOSTI CRIBBIO COLMO	126 / 129 130 / 134 136 / 139 140 / 143 144 / 145 158 / 163 164 / 167
GRUCCE HANGER	GRU	134 / 135
CESTINI BASKETS	BIRILLO STATUS TABOO ECO/ECO PRO CRIBBIO COLMO	168 / 173 174 / 179 180 / 183 184 / 191 158 / 163 164 / 167
PORTAOMBRELLI UMBRELLA STAND	BIRILLO CRIBBIO COLMO	168 / 173 158 / 163 164 / 167
POSACENERE DA TERRA FLOOR ASHTRAY	BIRILLO CRIBBIO COLMO	168 / 173 158 / 163 164 / 167

		PAGE
COLLEZIONI IN ACCIAIO INOX STAINLESS STEEL COLLECTIONS		146/155 194 / 219
APPENDIABITI COAT	NOX IPSO NOX EGO NOX VESTA NOX VESTA wall	146/149 - 203 150/153 - 218 210 / 217 154/155 - 219
CESTINI BASKET	NOX NOX MAGNUM	194 / 201 204 / 207
CESTINI DA PARETE WALL BASKET	NOX WALL	202 / 203
PORTAOMBRELLI UMBRELLA STAND	NOX NOX MAGNUM	194 / 201 204 / 207
POSACENERE DA TERRA FLOOR ASHTRAY	NOX	194 / 201
POSACENERE DA PARETE WALL ASHTRAY	NOX WALL	202/203
FIORIERE PLANTERS	NOX FLORA	203 - 208/209
SET DA SCRIVANIA E PARETE DESK AND WALL SETS	STATUS BABELE STANDARD	222 / 229 230 / 235 236 / 243
ACCESSORI DA SCRIVANIA DESK ACCESSORIES	HANNIBAL MULTIPLOR DUPLO GEMINI SAFE TRAY NOX	244 / 245 244 / 245 244 / 245 244 / 245 244 / 245 244 / 245
OROLOGI DA PARETE WALL CLOCKS	APPUNTAMENTO CONTRATTEMPO ORARIO ZERO	250 250 251 251
SCHEDA TECNICHE TECHNICAL INFO		252/271
COLORI E MATERIALI COLOURS AND MATERIALS		272/280

OLIVIA

design Raul Barbieri 2004

2500. OLIVIA
sedia impilabile
stackable chair

La sedia Olivia è capostipite di una articolata collezione di sedute. E' contraddistinta dalla linea morbida e dal foro rotondo nello schienale: un cerchio perfetto, una vera icona distintiva. La seduta è realizzata in polipropilene in una gamma di 11 colori, la struttura è in acciaio cromato.

The Olivia chair is the prototype of a comprehensive sitting collection. The main feature of this softly styled chair is the backrest featuring a perfect circular hole: a true distinctive icon. Seat made of polypropylene in colours from a range of 11; chromium plated steel frame.

La chaise Olivia est à la tête d'une collection articulée d'assises. Elle se caractérise par la douceur des ses lignes et par le trou rond dans le dossier: un cercle parfait, une vraie icône distinctive. L'assise est réalisée en polypropylène en 11 coloris, le structure en acier chromé.

Der Stuhl Olivia ist der Stammvater der umfangreichen Sitz-Kollektion. Er unterscheidet sich durch seine weiche Linie und die runde Bohrung in der Rückenlehne: ein perfekter Kreis, eine echte sich unterscheidende Ikone. Der Sitz wird in Polypropylen in 11 Farben und das Gestell in verchromten Stahl realisiert

La silla Olivia es el prototipo de una articulada colección de asientos. Se distingue por su línea suave y por su orificio redondo en el respaldo: un círculo perfecto, un verdadero icono distintivo. El asiento está realizado en polipropileno con una gama de 11 colores, la estructura es en acero cromado.



2500. OLIVIA
sedia impilabile
stackable chair



2501. OLIVIA
poltroncina impilabile
stackable armchair

La collezione comprende una grande varietà di tipologie: sedia e poltroncina impilabili, sedia e poltroncina su ruote, ad altezza fissa o regolabile con pistone a gas, sedie con tavoletta scrittoio destra o sinistra, sgabelli alti, sedute su barra.

The collection includes a great variety of types: stackable chairs and armchairs, castor chairs and armchairs, with fixed or gas lift adjustable height, chairs fitted with right or left writing tablet, kitchen and bar stools, ganging rail seating systems.

La collection comprend une grande variété de typologies: chaise et fauteuil empilables, chaise et fauteuil sur roulettes, à hauteur fixe ou réglable par piston à gaz, chaises avec tablette écriteoire droite ou gauche, tabourets hauts, assises sur poutre.

Diese Kollektion besteht aus umfangreichen Varianten: stapelbare Stühle und Armlehnstühle, Stühle und Armlehnstühle auf Rollen, starre oder höhenverstellbare, Stühle mit rechtem oder linkem Klappptisch, Hocker, Sitze auf Schiene

La colección comprende una gran variedad de tipos: silla y silloncito apilables, silla y silloncito con ruedas, con altura fija o regulable con pistón a gas, silla con mesita abatible derecha o izquierda, taburetes, asientos en bancada.



2500. OLIVIA
sedia impilabile
stackable chair

2503. OLIVIA
sedia su ruote con elevazione a gas
swivel chair with gas lift

2501. OLIVIA
poltroncina impilabile
stackable armchair

2505. OLIVIA
poltroncina su ruote con elevazione a gas
swivel armchair with gas lift

2508. OLIVIA
sgabello alto
bar stool

2506. OLIVIA
sgabello medio
kitchen stool

2501. OLIVIA
poltroncina impilabile
stackable armchair

2502. OLIVIA
sedia su ruote
swivel chair



2500. OLIVIA
sedia impilabile
stackable chair



2505. OLIVIA
poltroncina su ruote
con elevazione a gas
swivel armchair with gas lift

2502. OLIVIA
sedia su ruote
swivel chair



La barra, attrezzabile da 2 a 5 posti con sedute e tavolini, è in acciaio verniciato alluminio; le sedute sono disponibili in 11 colori. Le gambe con piedini regolabili e i braccioli opzionali sono in acciaio cromato. I tavolini sono in stratificato melaminico antigraffio bianco o grigio.

The aluminium varnished steel ganging rail can be equipped with 2 to 5 seats and side-tables. Seats available in 11 colours; legs with adjustable feet and optional armrests in chromium plated steel. Table-tops in white or grey anti-scratch stratified melamine.

La poutre, aménageable librement de 2 à 5 places avec des assises et des petite tables, est en acier verni aluminium. Les assises, disponibles en 11 coloris, peuvent présenter des accoudoirs en acier chromé, ainsi que le piétement avec des pieds réglables. Les petite tables sont en stratifié mélaminique anti-rayures blanc ou gris.

Die Schiene, die für 2 bis 5 Plätzen mit Sitzen und Beistelltischen ausgerüstet werden kann, besteht aus Stahl, alufarbig lackiert. Sitze in 11 Farben; Armlehnen aus verchromtem Stahl, so wie die Beine mit verstellbaren Fußenden. Beistelltischen aus kratzfestem Hochdruck-Schichtpreßstoff, weiss oder grau.

La bancada en acero acabado aluminio se puede componer libremente con asientos y mesitas, de 2 a 5. Los asientos, disponibles en 11 colores, están dotados de brazos en acero cromado, al igual que las patas con los pies regulables. Las mesitas son en compacto melaminico antiarañazos blanco o gris.



OLIVIA
sedute e tavolini su barra
seats and tables on ganging rail



Il giunto di collegamento, unificato per le collezioni Olivia e Alexa, è stato studiato per poter collegare tra loro sia le sedie che le poltroncine. Il carrello "pick-up", in acciaio verniciato, è ideale per spostare velocemente sia Olivia, che Alexa ed Eveline.

Connection joint specific for the Olivia and Alexa collections, designed for joining both chairs and armchairs. The "pick-up" trolley, in varnished steel, is a fast option for moving Olivia, Alexa and Eveline around.

Le crochet de connexion, standardisé pour les collections Olivia et Alexa, a été conçu pour pouvoir joindre les chaises et aussi les fauteuils. Le chariot "pick-up", en acier verni, est l'idéal pour déplacer rapidement Olivia, Alexa et Eveline.

Der für die Kollektionen Olivia und Alexa vereintes Verbindungsteil wurde für den Zusammenbau sowohl der Stühle als auch der Armlehnstühle konzipiert. Der Olivia, Alexa und Eveline "pick-up" Wagen aus lackiertem Stahl ist ideal für eine rasche Verschiebung.

La conexión entresillas, unificada para las colecciones Olivia y Alexa, ha sido estudiada para poder unir entre sí tanto las sillas como los silloncitos. El carro "pick-up", en acero pintado, es ideal para desplazar rápidamente tanto a Olivia, Alexa como Eveline.



115.
carrello di servizio per OLIVIA, ALEXA e EVELINE
trolley for OLIVIA, ALEXA and EVELINE

114.
giunto di collegamento per OLIVIA e ALEXA
connecting joint for OLIVIA and ALEXA

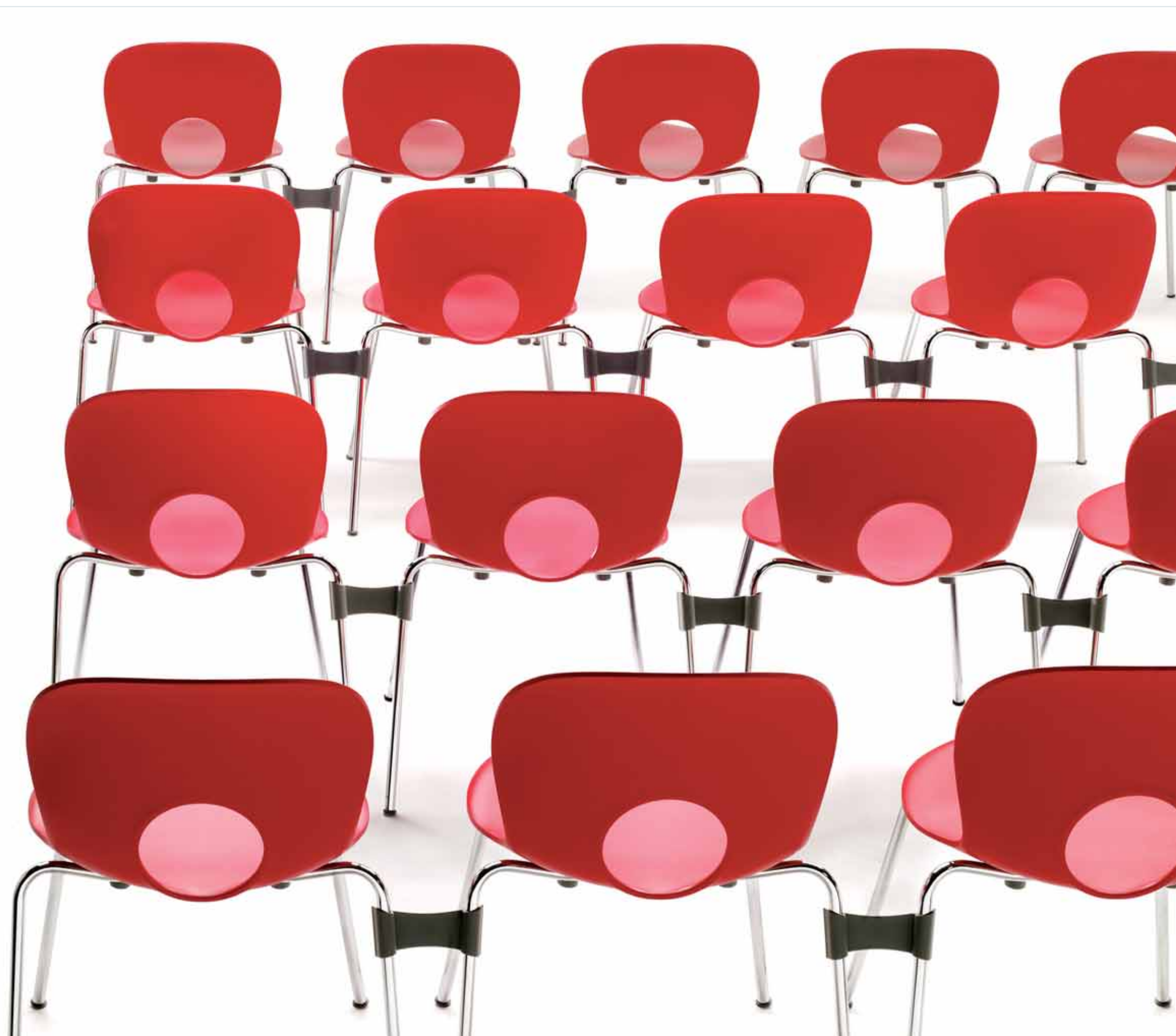



Olivia è disponibile anche in versione con tavoletta scrittoio destra o sinistra. La tavoletta-scrittoio è realizzata in polimero tecnico nero e dotata di snodo antipánico.

Olivia is also available in a version fitted with right or left writing tablet. The writing tablet is made of black engineering polymer and is provided with anti-panic mechanism.

Olivia est aussi disponible dans la version avec tablette écrioire droite ou gauche. La tablette écrioire est réalisée en polymère technique noir et elle est pourvue d'un joint anti-panique.

Olivia ist auch in der Version mit rechtem bzw. linkem Klapp Tisch erhältlich. Der Klapp Tisch ist aus schwarzem Technischem-Polymer und ist mit einem Antipanic-Gelenk ausgestattet.

Olivia está disponible también en la versión con mesita abatible derecha o izquierda. La mesita-escritorio está realizada en polímero técnico negro y está dotada de junta antipánico.



2509. OLIVIA
sedia con tavoletta ribaltabile
chair with folding tablet



ALEXA

design Raul Barbieri 2006

2520. ALEXA
sedia impilabile
stackable chair

La struttura leggera ed elegante, dalla linea sensuale, è realizzata in alluminio pressofuso, proposto con finitura lucidata, cromata o verniciata antigraffio "silver" e in altri 11 colori. Seduta e schienale sono realizzati in polipropilene in tutti gli 11 colori della struttura, o rivestiti in cuoio o ecopelle.

Light, elegant and sensually designed frame realized in die-cast aluminium. Available with polished and chrome finish or in the anti-scratch varnished version, in 11 colours and "silver". Seat and backrest made of polypropylene in the 11 frame matching colours, or with leather or eco-leather cover.

La structure légère et élégante, à la ligne sensuelle, est réalisée en aluminium moulé sous pression, proposée avec une finition polie, chromée ou vernie anti rayures "silver" et en d'autres 11 coloris. L'assise et le dossier sont réalisés en polypropylène dans tous les 11 coloris de la structure, ou recouvertes en cuir ou en ecopelle.

Das leicht und elegant Gestell von einer sinnlichen Linie wird aus Aluminium-Spritzguss hergestellt und ist erhältlich poliert, verchromt oder kratzfest lackiert in „Silver“ und in weiteren 11 Farben. Sitz und Rücken aus Polypropylen in allen 11 Farben des Gestell oder mit Leder und mit Eco-Leder bezogen.

Su estructura ligera y elegante, de línea sensual, está realizada en aluminio moldeado a presión, propuesto con acabado pulido, cromado o pintado antiarañazos "silver" y en otros 11 colores. El asiento y el respaldo están realizados en polipropileno en los 11 colores de la estructura, o revestidos en cuero o ecopelle.

2520. ALEXA
sedia impilabile
stackable chair



2521. ALEXA
poltroncina impilabile
stackable armchair



Finiture curate nei minimi dettagli per questa collezione di sedie e poltroncine con seduta e schienale rivestiti in cuoio o in ecopelle nelle tinte bianco, nero e testa di moro, con cuciture a vista. Straordinariamente confortevole, leggera, robusta, impilabile, Alexa è davvero ideale per gli spazi collettivi, oltre che per la casa.

Utmost care for finish and details characterize this chair and armchair collection with leather or eco-leather coated seat and backrest, in white, black and dark chocolate, with exposed stitching. Incredibly comfortable, light, strong and stackable, Alexa is the best solution for both common areas and home.

Finitions soignées dans les moindres détails pour cette collection de chaises et de fauteuils avec assise et dossier revêtu de cuir ou de ecopelle en blanc, noir ou tête de maure, avec les coutures visibles. Extrêmement confortable, légère, solide, empilable, Alexa est vraiment l'idéal pour les espaces collectifs, ainsi que pour un usage domestique.

Im Detail sorgfältig durchgeführte Nacharbeiten für die Kollektion Stühle und Armlehnstühle, mit weißem, schwarzen oder dunkelbraunen Leder oder mit Eco-Leder bezogenen Sitzen und Rückenlehnen, mit sichtbaren Nähten. Außergewöhnlich komfortabel, leicht und stark, sowie stapelbar ist Alexa wirklich ideal sowohl für Versammlungsräume als auch für die Wohnung.

Acabados cuidados hasta el más mínimo detalle para esta colección de sillas y silloncitos con asiento y respaldo revestidos en cuero o ecopelle en blanco, negro, marrón oscuro, con costuras a la vista. Extraordinariamente confortable, ligera, robusta, apilable, Alexa es realmente ideal para los espacios colectivos, además de para la casa.

2520. ALEXA
sedia impilabile
stackable chair



Alexa, come Olivia, è disponibile anche in versione con tavoletta scrittoio destra o sinistra. La tavoletta scrittoio è sempre realizzata in polimero tecnico nero e dotata di snodo antipánico.

Alexa, like Olivia, is also available in a version fitted with right or left writing tablet. Also in this case the tablet is made of black engineering polymer and features an anti-panic mechanism.

Alexa, comme Olivia, est aussi disponible dans la version avec tablette écriitoare droite ou gauche. La tablette écriitoare est toujours réalisée en polymère technique noir avec joint anti-panique.

Alexa, so wie Olivia, ist auch in der Version mit rechtem bzw. linkem Klappptisch erhältlich. Der Klappptisch ist auch hier aus schwarzem Technischem-Polymer und verfügt über ein Antipantik-Gelenk.

Alexa, como Olivia, está disponible con mesita abatible derecha o izquierda. La mesita-escritorio siempre está realizada en polímero técnico negro y dotada de junta antipánico.



2529. ALEXA
sedia con tavoletta
chair with tablet arm





EVELINE

design Raul Barbieri 2008

2540. **EVELINE**
sedia impilabile
stackable chair

Una sedia impilabile elegante, leggera, straordinariamente confortevole e dall'elevata resistenza strutturale che la rende perfetta sia per gli ambiti privati che per gli spazi collettivi. Realizzata in policarbonato in un unico pezzo, è proposta in colori trasparenti o solidi, oppure verniciata silver, gold e nero "soft touch".

An elegant stackable chair, light and incredibly comfortable, with a sturdy frame which makes it perfect for both home and common areas.

A single-piece polycarbonate item that comes in transparent or solid colours, or varnished in silver, gold or black "soft touch".

Une chaise empilable élégante, légère, extraordinairement confortable et dont la structure très résistante fait en sorte qu'elle soit parfaite pour les milieux privés et pour les espaces collectifs.

Réalisée en polycarbonate en une seule pièce, elle est proposée dans des couleurs transparentes ou solides, ou bien vernie en silver, gold et noir "soft touch".

Ein stapelbarer, eleganter, leichter und außergewöhnlich komfortabler Stuhl von einer hoch strukturellen Festigkeit, ist bestens geeignet sowohl für die Wohnung als auch für Versammlungsräume. Aus einem Stück Polykarbonat hergestellt und erhältlich in Transparent- oder durchgefärbten Farben oder auch silver, gold und schwarz „soft touch“ lackiert.

Una silla apilable elegante, ligera, extraordinariamente confortable y con una alta resistencia estructural que la hace perfecta tanto para los espacios privados como para los colectivos. Realizada en policarbonato de una sola pieza, disponible en colores transparentes o sólidos, o pintada en silver, gold o negro "soft touch".











SGABELLI STOOLS

Sedute informali, ma sempre ergonomiche e versatili. Tanti modelli, ognuno con la sua personalità e le sue caratteristiche funzionali per coprire una infinita gamma di utilizzi.

Informal seats that never forget ergonomics and versatility. A wealth of models, each with a distinctive personality and functional features able to cater for unlimited purposes.

Assises informelles, mais toujours ergonomiques et polyvalentes. De nombreux modèles, chacun avec sa personnalité et ses caractéristiques fonctionnelles pour remplir une gamme infinie d'utilisation.

Informelle, jedoch ergonomische und gewandte Sitze, jeder mit eigener Persönlichkeit und funktionelle Eigenschaften für unzählige Benutzungsmöglichkeiten.

Asientos informales, pero siempre ergonómicos y versátiles. Tantos modelos, cada uno con su personalidad y sus características funcionales para cubrir una infinidad de tipos de uso.

2210. ZANZIBAR
sgabello ad altezza regolabile
stool with adjustable height





ZANZIBAR

design Raul Barbieri 2001

La collezione Zanzibar, oltre alla versione classica regolabile in altezza con pistone a gas, comprende anche tre modelli ad altezza fissa, alti rispettivamente 47,5, 65 e 77 cm e un modello con fissaggio a pavimento. La seduta e il cono sono in polimero tecnico in vari colori o verniciato alluminio, pulsanti cromati.

In addition to the classic gas lift height adjustable version, the Zanzibar collection also features three fixed height models, respectively 47.5, 65 and 77 cm (18^{3/4}, 25^{1/2} and 30^{1/4}) as well as a floor mounted option. Seat and cone in engineering polymer in various colours or aluminium finish, chromium plated push-buttons.

La collezione Zanzibar, en plus de sa version classique réglable en hauteur par piston à gaz, comprend aussi trois modèles à hauteur fixe, dont la hauteur atteint 47,5, 65 et 77 cm et un modèle avec fixation au sol. L'assise et le cône sont en polymère technique en plusieurs coloris ou verni en aluminium, poussoirs chromés.

Die Zanzibar Kollektion, außer in der klassischen mit Gasfeder höhenverstellbaren Ausführung ist auch in drei Modellen von fester Höhe, und zwar 47,5, 65 und 77 cm, sowie mit einem am Boden befestigendes Modell erhältlich. Sitz und Kegel aus Technischem-Polymer in verschiedenen Farben oder alufarbig lackiert, verchromte Drucktasten.

La colección Zanzibar, además de la versión clásica con altura regulable con pistón a gas, también incluye tres modelos con una altura fija de 47,5, 65 y 77 cm respectivamente, y un modelo que se fija al suelo. El asiento y el cono son en polímero técnico en varios colores o pintado aluminio, pulsadores cromados.

2210. ZANZIBAR
sgabello ad altezza regolabile
stool with adjustable height



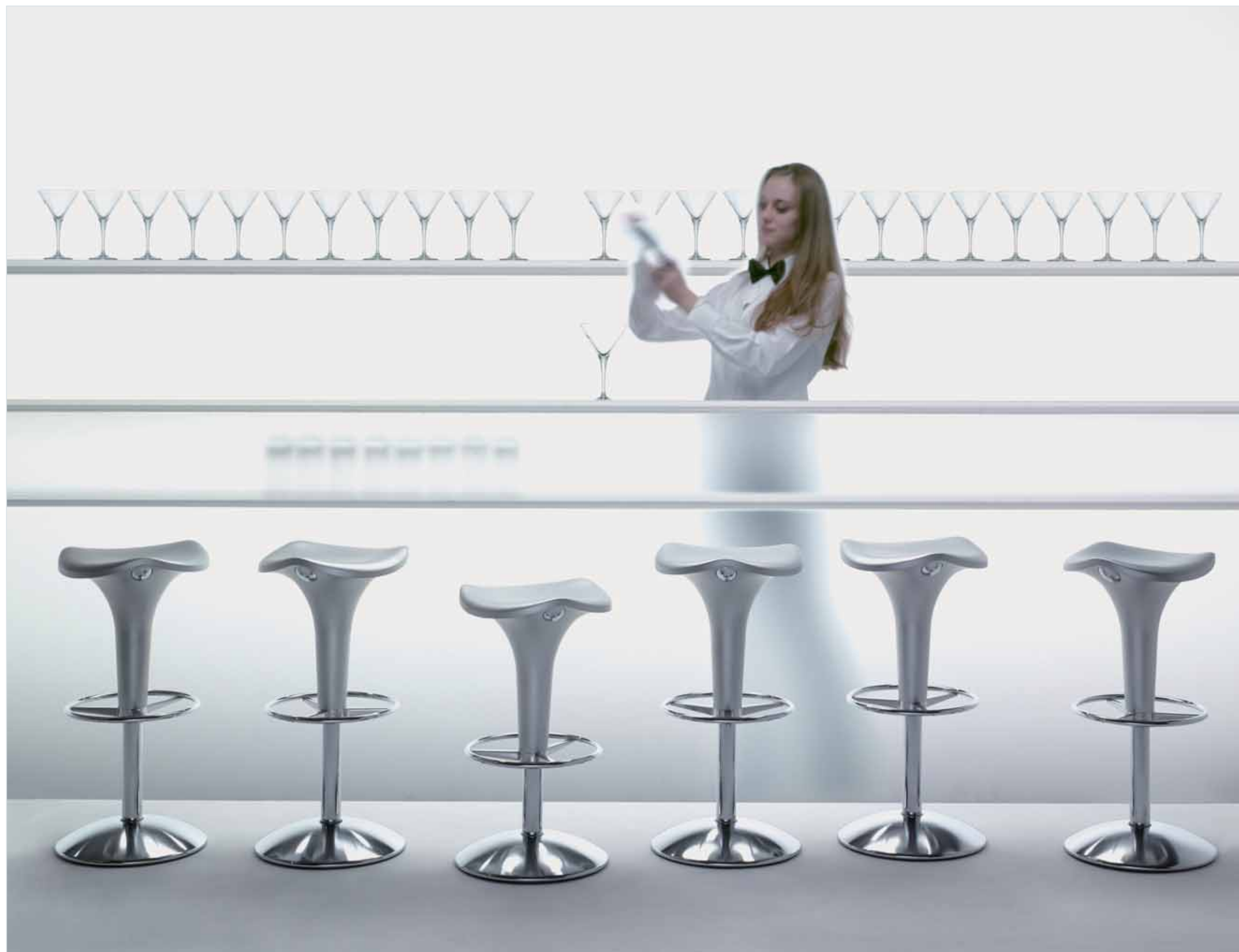

2210. ZANZIBAR
sgabello ad altezza regolabile
stool with adjustable height



ZANZI SWING

design Raul Barbieri 2002

Sgabelli basculanti ad altezza regolabile con pistone a gas. Seduta e cono in polimero tecnico in vari colori o verniciati alluminio, pulsanti cromati.

Gas lift adjustable height swinging stools. Seat and cone made of engineering polymer in various colours or aluminium finish; chromium plated push-buttons.

Tabourets basculants à hauteur réglable par piston à gaz. Assise et cône en polymère technique en plusieurs coloris ou vernis en aluminium, poussoirs chromés.

Schwinghocker, höhenverstellbar mit Gasfeder. Sitz und Kegel aus Technischem-Polymer in verschiedenen Farben oder alufarbig lackiert; verchromte Drucktasten.

Taburetes basculantes con altura regulable con pistón a gas. Asiento y cono en polímero técnico en varios colores o pintado aluminio, pulsadores cromados.



2220. ZANZI SWING
sgabello basculante ad altezza regolabile
swinging stool with adjustable height

2241. ZANZIPLANO
tavolino quadrato
square table



WELCOME

design Raul Barbieri 2003

Sgabello su ruote, ad altezza regolabile con pistone a gas. Struttura in acciaio cromato, seduta in polimero tecnico in vari colori abbinati ai copri-ruota, pulsanti cromati.

Gas lift adjustable height castor stool. Chromium plated steel frame, engineering polymer seat in various colours matching the castor guards; chromium plated push- buttons.

Tabouret sur roulettes, à hauteur réglable par piston à gaz. Structure en acier chromé, assise en polymère technique en différents coloris associés aux enjoliveurs.

Drehhocker auf Rollen, höhenverstellbar mit Gasfeder. Gestell aus verchromten Stahl, Sitz aus Technischem-Polymer in verschiedenen Farben, passenden mit der Rollen-Abdeckung; verchromte Drucktasten.

Taburete sobre ruedas, con altura regulable con pistón a gas. Estructura en acero cromado, asiento en polímero técnico en varios colores que combinan con la cobertura de las ruedas, pulsadores cromados.

**2265. WELCOME**

sgabello ad altezza regolabile su ruote
stool with adjustable height on castors



WELL

design Raul Barbieri 2003

Famiglia di sgabelli in 3 altezze, con struttura in acciaio cromato e seduta in polimero tecnico in vari colori. Il modello base è alto 45 cm ed è impilabile; modelli medio e alto, rispettivamente h 65 e 77 cm, sono dotati di appoggiatesta.

A family of stools that come in 3 heights, with chromium plated steel frame and engineering polymer seat in various colours. The basic 45 cm (17³/₄) high model is stackable; the kitchen and bar models are fitted with footrest and are 65 and 77 cm (25¹/₂ and 30¹/₄) high.

Set de tabourets sur 3 hauteurs, avec structure en acier chromé et assise en polymère technique en plusieurs coloris. Le modèle de base mesure 45 cm en hauteur et il est empilable; les modèles moyen et haut, respectivement de 65 et 77 cm, sont pourvus de repose-pieds.

Hockerfamilie in 3 Höhen. Gestell aus verchromtem Stahl und Sitz aus Technischem-Polymer in verschiedenen Farben. Das Grundmodell ist 45 cm hoch und stapelbar; die mittleren und hohen Modelle, von 65 und 77 cm sind mit einer Fußstütze ausgestattet.

Familia de taburetes de 3 alturas, con estructura en acero cromado y asiento en polímero técnico en varios colores. El modelo básico tiene 45 cm de alto y es apilable; los modelos medio y alto, 65 y 77 cm respectivamente, están dotados de apoyapiés.



2260. WELL
sgabello impilabile
stackable stool





2261. WELL
sgabello medio
kitchen stool

2262. WELL
sgabello alto
bar stool

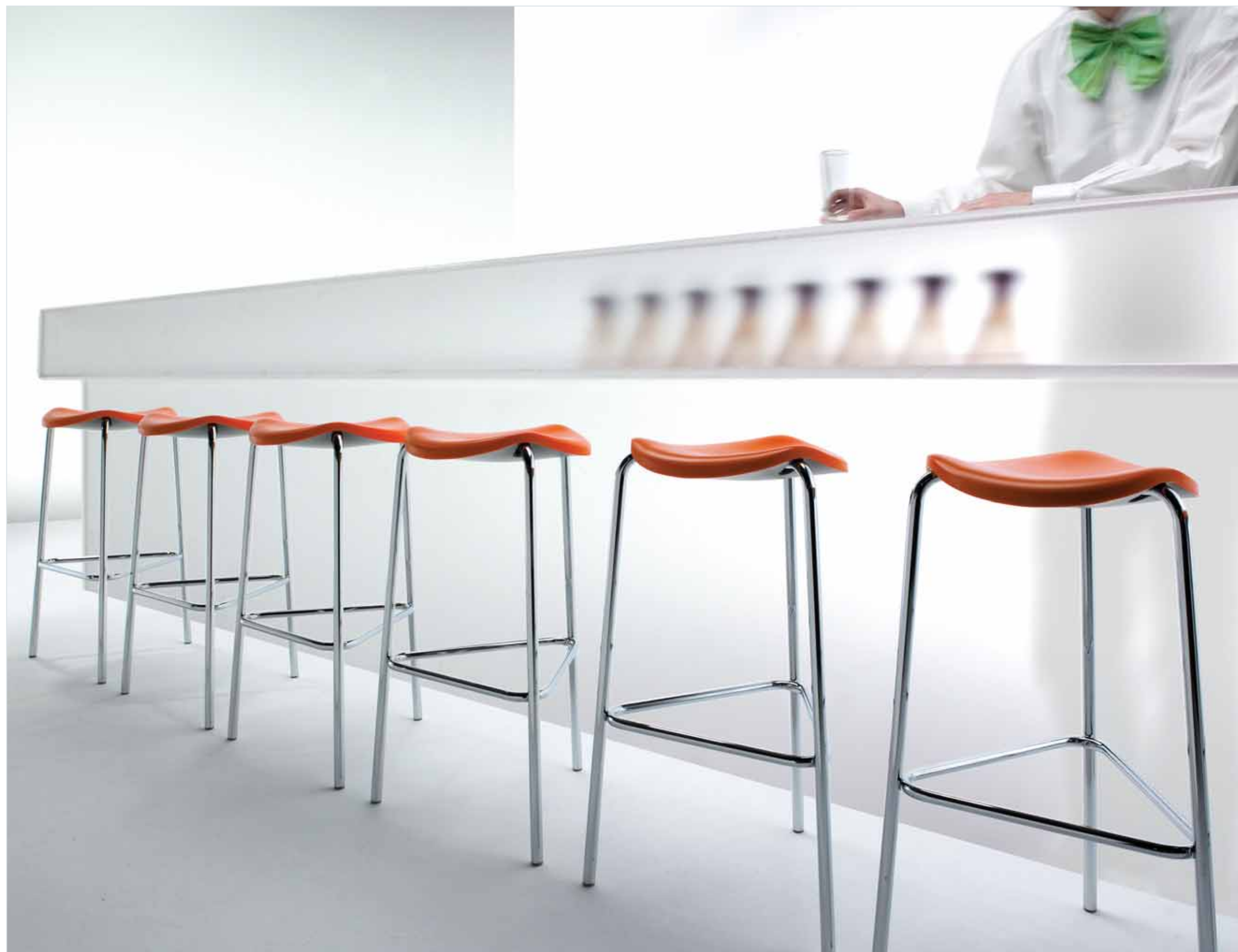

ZANZIPLANO
design Raul Barbieri 2004

2245. ZANZIPLANO
tavolo quadrato
square table



2250. ZANZIPLANO
tavolo rotondo
round table

Collezione di tavoli e tavolini quadrati e rotondi in due altezze, 75 e 105 cm, con piani in varie misure negli stessi colori bianco, grigio e rosso, del cono in polimero tecnico. Gamba e base in acciaio cromato, piano in stratificato melaminico antigraffio con bordo craft.

A collection of square and round tables and coffee tables in two heights, 75 e 105 cm (29^{1/2} and 41^{1/4}). Different top size options in white, grey and red to match the engineering polymer cone. Leg and base in chromium plated steel, anti-scratch stratified melamine top with crafted edge.

Collection de tables et guerdons carrées et rondes sur deux hauteurs, 75 et 105 cm, dont les plateaux de plusieurs dimensions sont des mêmes coloris blanc, gris et rouge du cône en polymère technique. Base et pied en acier chromé, plateau en stratifié mélaminique anti-rayures avec bord craft.

Kollektion Tische und Beistelltische, viereckige und runde, in zwei Höhen: 75 und 105 cm, mit Tischplatte von verschiedenen Größen in den gleichen Farben weiß, grau und rot, wie der Kegel aus Technischem-Polymer. Tischfuß und Sockel aus verchromten Stahl, Platte aus kratzfestem Hochdruck-Schichtpreßstoff mit Craft-Rand.

Colección de mesas y mesitas cuadradas y redondas en dos alturas, 75 y 105 cm, con tapas en distintas medidas en los mismos colores, blanco, gris y rojo, que el cono realizado en polímero técnico. Pata y base en acero cromado, tapa en compacto melaminico antirarañazos con borde craft.

2245. ZANZIPLANO

tavolo quadrato
square table

2239. ZANZIPLANO

tavolino rotondo
round table



2250. ZANZIPLANO

tavolo rotondo
round table

2242. ZANZIPLANO

tavolino alto
high table



2242. ZANZIPLANO
tavolino alto
high table



2250. ZANZIPLANO
tavolo rotondo
round table
2501. OLIVIA
poltroncina impilabile
stackable armchair



ENRICO X

design Alberto Basaglia
e Natalia Rota Nodari 2007



Sistema di tavoli con struttura in alluminio anodizzato naturale e angolari lucidati. Il piano, contenuto nel profilo, è in laminato bianco, rovere, wengè, oppure in cristallo temperato trasparente, opaco o bianco.

Table system featuring natural anodised aluminium frame and polished aluminium corners. The top, held by the frame, is made of white, oak or wenge laminate or of transparent, mat or white tempered crystal.

Système de tables avec une structure en aluminium anodisé naturel et angulaires en aluminium poli. Le plateau, intégré dans le profil, est en laminé blanc, rouvre, wengé, ou en cristal trempé transparent, dépoli ou blanc.

Tisch-System mit Gestell aus natureloxiertem Aluminium und polierten Ecken. Die im Profil eingebaute Tischplatte ist aus melamine Laminat weiss, grau, Eiche, Wengé oder aus Hartglas transparent, matt oder weiss.

Sistema de mesas con estructura en aluminio anodizado natural y ángulos en aluminio pulido. La tapa, situada dentro de los perfiles, es en laminado blanco, roble, wengé, o en cristal templado transparente, matizado o blanco.



2074. ENRICO X
tavolo rettangolare
rectangular table

2540. EVELINE
sedia impilabile
stackable chair

CONVITO

design Raul Barbieri 2005



2144. CONVITO
tavolo rettangolare
rectangular table
2540. EVELINE
sedia impilabile
stackable chair

Le versioni dei tavoli Convito sono numerose: esiste in formato rotondo con diametro 135 cm per 6 persone, quadrato 140x140 cm per 8 persone e in vari modelli rettangolari adatti per 6, 8 o 10 persone. La struttura è realizzata interamente in acciaio inossidabile satinato, i piani sono in cristallo temperato trasparente, opaco o bianco

Convito tables come in several sizes: round (diameter 135 cm - 53 1/4") sitting 6, square (140x140 cm - 55 x 55") sitting 8 and several rectangular versions suitable for 6, 8 or 10. The frame is wholly made of brushed stainless steel and tops are in transparent, mat or white tempered crystal.

Les versions des tables Convito sont nombreuses: il existe un format rond avec diamètre 135 cm pour 6 personnes, un carré 140 x 140 cm pour 8 personnes et plusieurs modèles rectangulaires pour 6, 8 ou 10 personnes. La structure est entièrement réalisée en acier inoxydable satiné, les plateaux sont en cristal trempé transparent, dépoli ou blanc.

Die Convito Tischen sind in zahlreiche Versionen erhältlich: runde Tische mit einem Durchmesser von 135 cm für 6 Personen, viereckige 140x140 cm für 8 Personen und verschiedene rechteckige Modelle für 6, 8 oder 10 Personen. Das Gestell ist vollständig aus satiniertem Edelstahl, die Tischplatte ist aus Hartglas transparent, matt oder weiss.

Las versiones de las mesas Convito son numerosas: existe en formato redondo con diámetro 135 cm para 6 personas, cuadrado 140x140 cm para 8 personas y en varios modelos rectangulares para 6, 8, ó 10 personas. La estructura está realizada completamente en acero inoxidable satinado, las superficies son en cristal templado transparente, matizado o blanco.



2144. CONVITO
tavolo rettangolare
rectangular table
2140. CONVITO
tavolo quadrato
square table





2135. CONVITO
tavolo rotondo
round table

2505. OLIVIA
poltroncina su ruote con elevazione a gas
swivel armchair with gas lift

2500. OLIVIA
sedia impilabile
stackable chair



ALEX

design Raul Barbieri 2007



2150. ALEX
tavolo quadrato
square table

2521. ALEXA
poltroncina impilabile
stackable armchair



Sofisticata linea di tavoli con struttura in fusione di alluminio e piani in cristallo. La struttura ripropone la linea elegante delle sedute Alexa ed è proposta in finitura lucidata, cromata oppure verniciata antigraffio bianco o nero. Il piano è in cristallo temperato trasparente, opaco o bianco.

A sophisticated table range featuring aluminium casting frame and crystal top. The frame revisits the typical posh desing of the Alexa chairs with polished, chrome finish or white or black anti-scratch varnished versions. Top in transparent, mat or white tempered crystal.

Une série sophistiquée de tables avec une structure en fusion d'aluminium et plateaux en cristal. La structure rappelle la ligne élégante des assises Alexa et elle est proposée avec une finition polie, chromée ou vernie anti rayure blanc ou noir. Le plateau est en cristal trempé transparent, dépoli ou blanc.

Eine hochentwickelte Tischlinie mit Aluminiumguß Gestell und Tischplatte aus Hartglas. Das Gestell lehnt sich der eleganten Linie der Alexa Stuhl an und ist poliert, verchromt oder weiß und schwarz kratzfest lackiert. Die Tischplatte ist aus Hartglas, transparent, matt oder weiß.

Sofisticada línea de mesas con estructura en fusión de aluminio y tapa en cristal. La estructura repropone la línea elegante de los asientos Alexa y está disponible con acabado pulido, cromado o pintado antiarañazos blanco o negro. La tapa es de cristal templado transparente, matizado o blanco.

2150. ALEX
tavolo quadrato
square table

2521. ALEXA
poltroncina impilabile
stackable armchair



2154. ALEX
tavolo rettangolare
rectangular table

2521. ALEXA
sedia impilabile
stackable chair

POPPY

design Raul Barbieri 2010

2101. POPPY
tavolino rotondo
round table

Collezione di tavolini in due diametri, 38 e 50 cm, e in tre altezze, 40, 56 e 72 cm, ideale sia per ambiti privati che per spazi collettivi. La base in acciaio è ricoperta da un cono in polimero tecnico bianco, rosso o nero, speculare al cono sottopiano; l'asta è in acciaio verniciato negli stessi colori. I piani in cristallo temperato bianco, rosso o nero consentono tutti gli abbinamenti cromatici.

A collection featuring coffee tables in two diameters, 38 and 50 cm (15 and 19^{3/4}) and three height options, 40, 56 and 72 cm (15^{3/4} - 22 and 28^{1/2}"), ideal for both home and common areas. The steel base is coated by a white, red or black engineering polymer cone which is specular to the under-top cone; leg in varnished steel in matching colours. Top made of white, red or black tempered crystal, suitable for all chromatic combinations.

Collection de guéridons proposées en deux diamètres, 38 et 50 cm, et en trois hauteurs, 40, 56 et 72 cm, idéale pour un usage domestique et pour les espaces collectifs. La base en acier est recouvert d'un cône en polymère technique blanc, rouge ou noir, spéculaire au cône sous-plateau; la tige est en acier verni des mêmes couleurs. Les plateaux de cristal trempé blanc, rouge ou noir permettent toutes les combinaisons chromatiques.

Die Kollektion, bestehend aus Beistelltischen mit zwei Durchmessern von 38 und 50 cm und in drei verschiedenen Höhen von 40, 56 und 72 cm, ist bestens geeignet sowohl für die Wohnung als auch für Versammlungsräume. Die Sockel hat eine Abdeckung aus Technischem-Polymer, weiß, rot oder schwarz, die spiegelbildlich zum oberen Unterseite der Tischplatte steht. Der Stahlfuß ist in den gleichen Farben lackiert. Die Tischplatten aus Hartglas, weiß, rot oder schwarz, sind für alle farblichen Kombinationen geeignet.

Colección de mesitas en dos diámetros, 38 y 50 cm, y en tres alturas, 40, 56 y 72 cm, ideal tanto para espacios privados como colectivos. La base en acero está recubierta por un cono en polímero técnico blanco, rojo o negro, especular con respecto al cono soto-tapa; la barra es en acero pintado en los mismos colores. Las tapas son en cristal templado blanco, rojo o negro permitiendo todas las combinaciones cromáticas.

2102. 2103. 2105. 2106. POPPY
tavolini rotondi
round tables



DESCO

design Raul Barbieri 2005

Linee pure e materiali sofisticati per metterle in risalto: questi tavolini ad altezza 45, 75 e 105 cm hanno la struttura in acciaio inossidabile satinato e un piano diam. 60 cm in cristallo temperato trasparente, opaco, bianco, nero o fumè.

Clean lines enhanced by sophisticated materials: these coffee tables, heights 45, 75 and 105 cm (17³/₄ - 29¹/₂ and 41¹/₂"), feature brushed stainless steel frame and top, diameter 60 cm (23¹/₂"), in transparent, mat, white, black or smoky tempered crystal.

Des lignes pures et des matières sophistiquées pour les mettre en évidence: ces tables basses d'une hauteur de 45, 75 et 105 cm ont base et pied en acier inoxydable satiné et plateau 60 cm de diamètre en cristal trempé transparent, poli, blanc, noir ou fumé.

Reine Linien und hoch qualitative Materialien, um sie im Vordergrund zu bringen: Beistelltische mit Höhen von 45, 75 und 105 cm und Durchmesser von 60 cm. Gestell aus satiniertem Edelstahl, Tischplatte aus Hartglas, transparent, matt, weiß, schwarz oder rauchfarbig.

Líneas puras y materiales sofisticados para resaltar: estas mesitas de 45, 75 y 105 cm de altura tienen una estructura en acero inoxidable satinado y una tapa con diámetro 60 cm en cristal transparente, matizado, blanco, negro o fumé.

**2129. 2131. DESCO**tavolini rotondi
round tables**2500. OLIVIA**
sedia impilabile
stackable chair

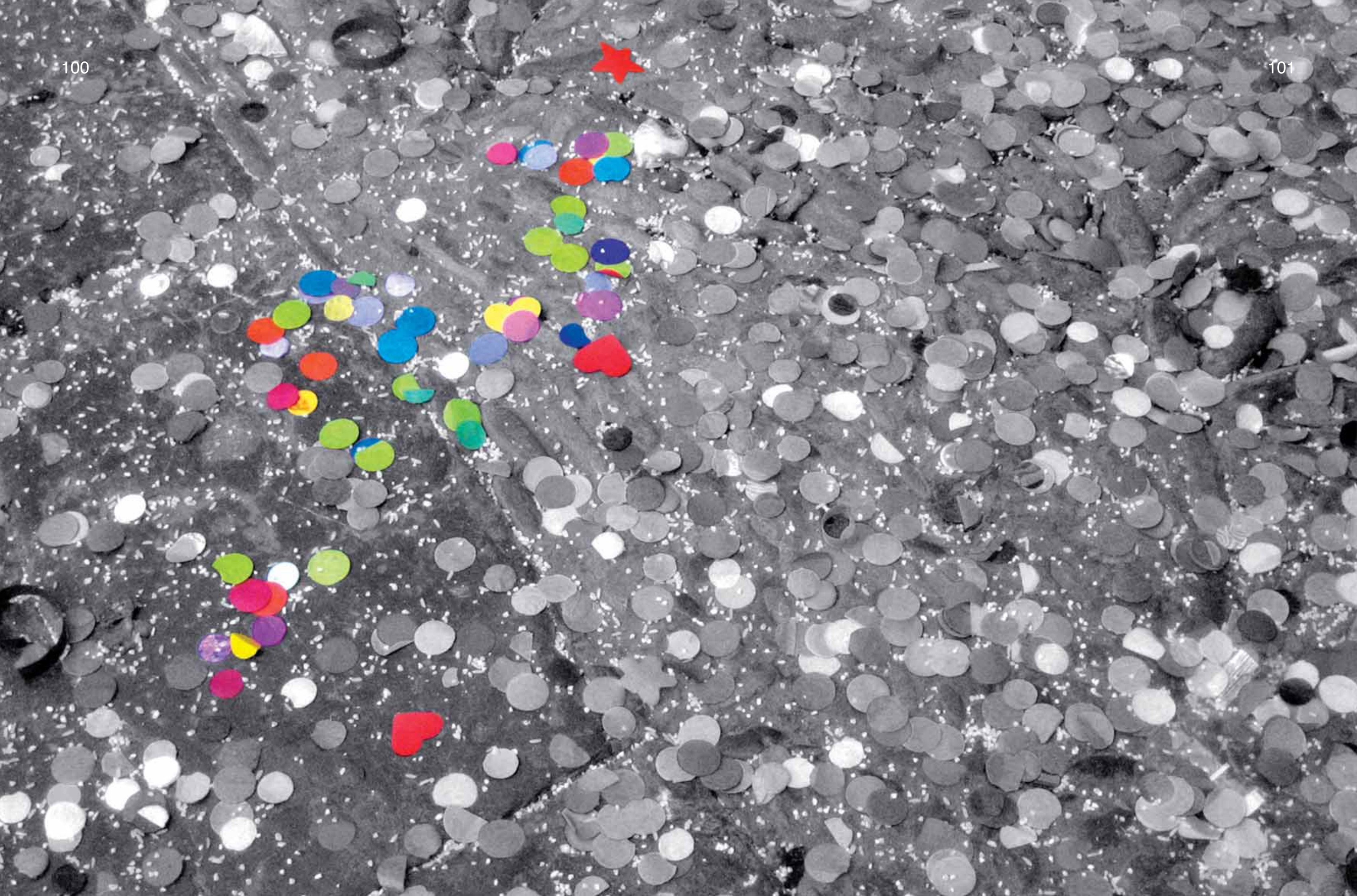

BANCO LIGHT

design Raul Barbieri 1998

Scrivania per computer con struttura in alluminio e piani in cristallo temperato opaco oppure in stratificato melaminico, bianco ghiaccio o grigio. Il ripiano inferiore, ideale per collocare la stampante, è meno profondo per consentire una seduta confortevole. Può essere corredato di supporto estraibile porta-tastiera, in acciaio verniciato alluminio.

Computer desk with aluminium frame and top in mat tempered crystal or in ice or grey stratified melamine. The lower shelf, ideal for placing the printer, is narrower to allow comfortable sitting. Optional extractable keyboard holder in aluminium varnished steel.

Escritorio para ordenador con estructura en aluminio y estantes en cristal templado depoli o en stratifié melaminico, couleur glace ou gris. L'étagère inférieure, idéale pour accueillir l'imprimante, est moins profonde pour permettre une position assise confortable. On peut ajouter un plan escamotable pour le clavier, en acier verni aluminium.

Computerschreibtisch mit Gestell aus Aluminium und Fachböden aus mattem Hartglas oder aus eisfarbigem und grauem Hochdruck-Schichtpreßstoff. Das untere Fach, wo gut ein Drucker untergebracht werden kann, ist weniger tief, damit man bequem sitzen kann. Kann mit einem Ausziehfach für Tastatur aus alufarbigem Stahl ausgestattet werden.

Escritorio para ordenador con estructura en aluminio y estantes en cristal templado matizado o en compacto melaminico, blanco-hielo o gris. El estante inferior, ideal para colocar la impresora, es menos profundo para permitir que se pueda sentar de manera cómoda. Puede acompañarse de tablero extraíble porta-teclado, en acero acabado aluminio.



201.
supporto estraibile per tastiera
pull-out tray for keyboard



2021. BANCO LIGHT
scrivania per computer
computer desk

2505. OLIVIA
poltroncina su ruote con elevazione a gas
swivel armchair with gas lift

TENDER

design Raul Barbieri 1998

Carrello con struttura in acciaio cromato, vassoi e copriuote in polimero tecnico nero, bianco translucido o verniciato alluminio. Sono disponibili anche singoli vassoi Tender nelle stesse finiture, perfettamente sovrapponibili al carrello.

Trolley with chromium plated steel frame and trays and castor guards in black, translucent white, or aluminium finish engineering polymer. Extra stackable Tender trays in matching finish are also available.

Chariot avec structure en acier chromé, plateaux et enjoliveurs en polymère technique noir, blanc translucide ou verni aluminium. Il existe aussi des plateaux Tender, disponibles séparément, ayant les mêmes finitions, parfaitement superposables au chariot.

Servierwagen mit Gestell aus verchromtem Stahl, Tablette und Rollen-Abdeckung aus Technischem-Polymer, schwarz, transparent-weiss oder alufarbig. Die Tender Tablette sind auch einzeln erhältlich und können perfekt im Wagen übereinander gelegt werden.

Carro con estructura en acero cromado, bandejas y cobertura de las ruedas en polímero técnico negro, blanco translúcido o acabado aluminio. También están disponibles bandejas individuales con los mismos acabados, que se pueden sobreponer perfectamente en el carro.

**2301. TENDER**vassoio
tray**2299. TENDER**carrello
trolley

NEWS

design Raul Barbieri 1999

Portariviste pieghevole. La struttura è in alluminio con finitura naturale, i supporti in polipropilene possono essere in nero o bianco traslucido.

Folding magazine rack. Natural finish aluminium frame, black or translucent white polypropylene holders.

Porte-revues pliable. La structure est en aluminium avec finition naturel, les patins en polypropylène peuvent être en noir ou blanc translucide.

Klappzeitungsständer mit Gestell aus Aluminium, Unterlagen aus Polypropylen, schwarz oder transparent-weiss.

Porta revistas plegable. La estructura es en aluminio acabado natural, los soportes son en polipropileno negro o blanco translúcido.



2400. NEWS
portariviste pieghevole
folding magazine rack





BOOX

design Alberto Basaglia
e Natalia Rota Nodari 2006

2700. **BOOX**
sistema contenitore modulare
modular shelving system

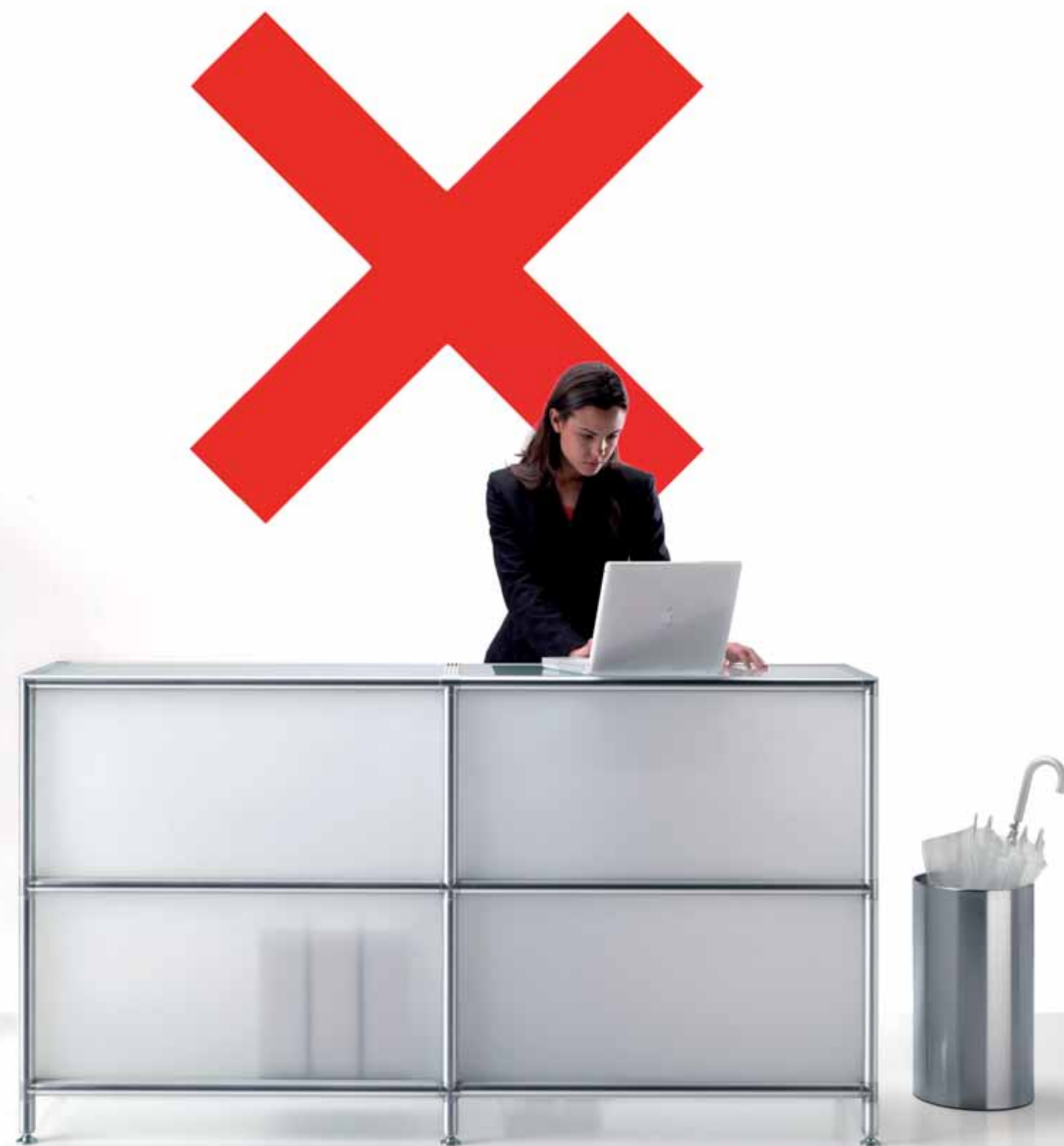

Sistema contenitore modulare con struttura in alluminio anodizzato naturale, piani in vetro temperato e pannelli in metacrilato. Il sistema offre una grande possibilità di composizioni, con moduli di larghezza 60 o 90 cm, altezza utile 35 o 40 cm, profondità 35 o 45 cm.

I ripiani sono in vetro temperato, trasparente, opaco, bianco, nero e finitura alluminio; i pannelli e le antine in metacrilato sono disponibili in vari colori, solidi, trasparenti o frost.

Modular shelving system with natural anodised aluminium frame, tempered glass shelves, methacrylate panels. The system offers a wide range of arrangements, with modules featuring width 60 or 90 cm (23¹/₂ or 35¹/₂"), usable height 35 or 40 cm (13³/₄ or 15³/₄") and depth 35 or 45 cm (13³/₄ or 17³/₄"). Shelves in transparent, mat, white, black and aluminium finish tempered glass; methacrylate panels and doors in different solid, transparent or frost colours.

Système de rangement modulaire avec structure en aluminium anodisé naturel, plateaux en verre trempé et panneaux en méthacrylate. Ce système offre une grande possibilité de compositions, avec des modules d'une largeur de 60 ou 90 cm, hauteur utile 35 ou 40 cm, profondeur 35 ou 45 cm.

Les plateaux sont en verre trempé, transparent, mat, blanc, noir et finition aluminium; les panneaux et les portes en méthacrylate sont disponibles en plusieurs coloris, solides, transparentes ou frost.



Modulares Behältersystem mit Rahmen aus tiefgezogenem Aluminium, natureloxiert, Fachböden aus Hartglas, Paneelen aus Metakrylat. Das System bietet zahlreiche Zusammensetzungsmöglichkeiten mit Modulen von 60 oder 90 cm Länge, 35 oder 40 cm nützliche Höhe und 35 oder 45 cm Tiefe.

Die Fachböden sind aus Hartglas, transparent, matt, weiß, schwarz oder alufarbig. Die Paneele und die Schiebetüren sind in verschiedenen Farben erhältlich, durchgefärbte, transparent oder frost.

Sistema contenedor modular con estructura en aluminio anodizado natural, estantes en cristal templado y paneles en metacrilato. El sistema ofrece una gran posibilidad de composiciones, con módulos de 60 ó 90 cm de longitud, 35 ó 40 cm de altura útil y 35 ó 45 cm de profundidad.

Los estantes son en cristal templado, transparente, matizado, blanco, negro y acabado aluminio; los paneles y las puertas de metacrilato están disponibles en diferentes colores, sólidos, transparentes o frost.



- 2700. BOOX**
sistema contenitore modulare
modular shelving system
- 2144. CONVITO**
tavolo rettangolare
rectangular table
- 2520. ALEXA**
sedia impilabile
stackable chair



2700. BOOX
sistema contenitore modulare
modular shelving system

BOOX DOPPIO

design Alberto Basaglia
e Natalia Rota Nodari 2007

Il sistema è disponibile anche con una doppia profondità (82 cm), particolarmente adatta per biblioteche, come libreria interparete accessibile da due fronti.

The system is also available in a double depth version (82 cm - 32 1/4"), particularly suitable for libraries as a bookcase partition wall accessible from both sides.

Le système est aussi disponible avec une double profondeur (82 cm), particulièrement adaptée pour les bibliothèques, comme librairie inter-cloison accessible des deux côtés.

Das System ist auch mit doppelter Tiefe (82 cm) erhältlich, besonders geeignet für Bibliotheken, als von zwei Seiten zugänglichen Bücherschrank.

El sistema está también disponible con doble profundidad (82 cm), especialmente adecuada para bibliotecas, como librería entre paredes accesible por los dos frentes.

2702. BOOX DOPPIO
sistema contenitore modulare
modular shelving system

2245. ZANZIPLANO
tavolo quadrato
square table

2500. OLIVIA
sedia impilabile
stackable chair





BOOX CORNER

design Alberto Basaglia
e Natalia Rota Nodari 2008

Il modulo angolare permette di creare delle composizioni continue con angoli a 90°, ideale anche per realizzare banconi reception chiusi su più lati. Il modulo angolare permette di creare delle composizioni continue con angoli a 90°, ideale anche per realizzare banconi reception chiusi su più lati.

This corner module allows creating continuous compositions with 90° angles. Also perfect for realizing reception desks enclosed on several sides.

Le module angulaire permet de créer des compositions continues avec des angles de 90°, c'est aussi l'idéal pour réaliser des comptoirs d'accueil fermés sur plusieurs côtés.

Mit der Ecklösung können ununterbrochene Zusammensetzungen mit einem Winkel von 90° realisiert werden, die eine ideale Lösung auch für auf mehreren Seiten geschlossene Rezeptionstische sind.

El módulo angular permite crear composiciones continuas con ángulos de 90°, ideal también para realizar mostradores para recepciones cerradas por varios lados

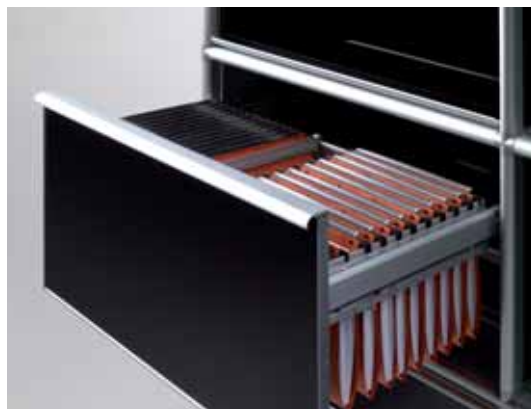

BOOX ACCESSORI

design Alberto Basaglia
e Natalia Rota Nodari 2007

Il sistema è completato da una serie di pratici accessori: antine scorrevoli con o senza chiave, ante basculanti, coppie di cassetti e cassetti per cartelle sospese. Tutti i frontalini sono rivestiti in metacrilato disponibile nei medesimi colori dei pannelli.

A series of handy accessories completes the series: lockable and non-lockable sliding doors, swinging doors, drawer pairs and drawers for suspension files. Methacrylate finish for all front parts in colours matching the panels.

Le système se complète d'une série d'accessoires très pratiques: portes coulissantes avec ou sans clé, des portes basculantes, des couples de tiroirs et tiroirs pour dossiers suspendus. Toutes les façades sont revêtus de méthacrylate et sont disponibles dans les mêmes coloris des panneaux.

Das System wird durch eine Serie von praktischen Zubehören vervollständigt: Schiebetüren mit oder ohne Schlüssel, Schwingtüren, Schubladen und Schubladen für Hängeregistratur. Alle Frontplatten sind aus Metakrylat, in den gleichen Farben der Paneelen.

El sistema se completa por una serie de accesorios prácticos: puertas correderas con o sin llave, puertas basculantes, parejas de cajones y cajones para carpetas suspendidas. Todos los frentes están revestidos en metacrilato disponible en los mismos colores de los paneles.



2700. BOOX
sistema contenitore modulare
modular shelving system



CACTUS

design Raul Barbieri 1995

1070. **CACTUS**
appendiabiti da terra con portaombrelli
coat stand with umbrella stand



Elegante appendiabiti da terra con portaombrelli incorporato. La testa e la base, provvista di zavorra, sono in polimero tecnico, l'asta è in acciaio verniciato. Le finiture sono alluminio e nero.

Sophisticated coat stand with built-in umbrella stand. The head and the fitted with ballast base are in engineering polymer, the leg is in varnished steel. Aluminium and black finish.

Un élégant portemanteau sur pied avec porte-parapluie incorporé. La tête et la base lesté sont en polymère technique, la tige est d'acier verni. Les finitions sont aluminium et noir.

Ein eleganter Kleiderständer mit eingebautem Schirmständer. Der Kopf und der Sockel mit Stahl-Kern sind aus Technischem-Polymer, die Stange ist aus lackiertem Stahl. Alufarbig oder schwarz erhältlich.

Elegante perchero de pie con paraguero incorporado. La cabeza y la base, provista de lastre, están realizadas en polímero técnico, la barra es en acero pintado. Los acabados son en aluminio y negro.



1070. CACTUS
appendiabiti da terra con portaombrelli
coat stand with umbrella stand

2129. DESCO
tavolino rotondo
round table

2500. OLIVIA
sedia impilabile
stackable chair



POP

design Raul Barbieri 2008



1080. POP
appendiabiti da terra
coat stand



Originale e suggestivo appendiabiti da terra, dotabile di vaschetta e anello con ganci per appendere gli ombrelli tascabili. La testa in polimero tecnico è realizzata con una sofisticata tecnica di stampaggio ad iniezione che consente un design dai volumi pieni e morbidi. La base in acciaio è ricoperta da un cono in polimero tecnico, l'asta è in acciaio verniciato. E' proposto nei colori solidi bianco, rosso, nero, grigio e in finitura alluminio oppure con asta e base in finitura alluminio con testa cristallo, arancio trasparente, blu trasparente.

Original and striking coat stand. Optional tray and ring umbrella stand fitted with hooks for hanging pocket umbrellas. The engineering polymer head is manufactured employing an advanced injection moulding technique to obtain a large and smooth design. Steel base coated by an engineering polymer cone, leg in varnished steel. Comes in solid white, red, black and grey or aluminium finish. Another version features aluminium finish leg and base combined with head in crystal or transparent orange or transparent blue.

Un original et suggestif portemanteau sur pied, peut être fourni avec soucoupe et anneau intermédiaire a crochets pouvant accueillir les parapluies de poche. La tête en polymère technique est réalisée suivant une technique sophistiquée de moulage par injection permettant un design aux volumes pleins et arrondis. La base en acier est recouvert d'un cône en polymère technique, la tige est en acier verni. Il est proposé dans les couleurs solides blanc, rouge, noir, gris et en finition aluminium ou avec tige et base en finition aluminium et tête en cristal, orange transparent, bleu transparent.

Ein origineller und eindrucksvoller Kleiderständer, kann auch mit einem Kit-Schirmständer ausgestattet werden, wo die Knipser aufgehängt werden können. Der Kopf aus Technischem-Polymer wurde durch ein hochentwickeltes Spritzgussverfahren realisiert, das ein voll voluminöses und geschmeidiges Design ermöglicht. Der Sockel aus Stahl hat eine Abdeckung aus Technischem-Polymer und die Stange ist aus lackiertem Stahl. Erhältlich in den durchgefärbten Farben weiß, rot, schwarz, grau und komplett alufarbig oder in der Ausführung mit Stange und Sockel alufarbig, Kopf kristall, transparent orange oder transparent blau.

Original y sugestivo perchero de pie, se puede dotar de cubeta y anillo con ganchos para colgar los paraguas de bolsillo. La cabeza en polímero técnico está realizada con una sofisticada técnica de moldeo por inyección que permite un diseño con volúmenes llenos y suaves. La base en acero está recubierta por un cono en polímero técnico, la barra es en acero pintado. Se encuentra en los colores sólidos blanco, rojo, negro, gris y acabado aluminio o con barra y base acabadas aluminio y cabeza en cristal, naranja transparente, azul transparente.

1080. POP
appendiabiti da terra
coat stand



1080. POP
appendiabiti da terra
coat stand
39.
kit portaombrelli per POP
umbrella stand kit for POP

GRU

design Raul Barbieri 2008

La gruccia Gru è il complemento ideale dell'appendiabiti Pop. Si ispira infatti agli stessi concetti funzionali e formali e ne ripropone sia materiali che finiture.

Gru coat hanger is the perfect complement for the Pop coat stand. As a matter of fact, it is inspired by the same functional and formal concepts and is made employing the same materials and finish options.

Le cintre Gru est le complément idéal du portemanteau Pop. En effet, il s'inspire des mêmes concepts fonctionnels et formels et il en repropose les matières et les finitions.

Der Kleiderbügel Gru ist eine ideale Ergänzung des Pop Kleiderständers. Er lehnt sich an die gleichen Funktions und Designkonzepten an und ist in der gleiche Ausführungen.

La percha Gru es el complemento ideal para el perchero Pop. De hecho, se inspira en los mismos conceptos funcionales y formales y está disponible en los mismos materiales y acabados.



DOPPIOPETTO

design Raul Barbieri 1992

1090. DOPPIOPETTO
appendiabiti da terra
coat stand



Importante ed elegante appendiabiti da terra, con confortevoli sostegni per abiti. Può essere provvisto di anello e vaschetta portaombrelli. Testa in polimero tecnico, asta in acciaio verniciato, base in acciaio rivestito in polimero tecnico. E' proposto in finitura alluminio o nero opaco.

Imposing and posh coat stand fitted with generous coat supports. Optional ring umbrella stand and tray. Head made of engineering polymer, leg in varnished steel, steel base with engineering polymer cover. Available with aluminium or mat black finish

Un important et élégant portemanteau sur pied, avec de confortables soutiens pour costumes. Il peut être fourni avec soucoupe et anneau porte-parapluies. Tête en polymère technique, tige en acier verni, base en acier avec couverture en polymère technique. Il est proposé avec finition aluminium ou noir mat.

Ein bedeutender und eleganter Kleiderständer mit komfortablen Kleiderhaken, der mit einem Kit-Schirmständer ausgestattet werden kann. Kopf aus Technischem-Polymer, Stange aus lackiertem Stahl, Stahlsockel mit Technischem-Polymer Abdeckung. Alufarbig oder mattschwarz erhältlich.

Importante y elegante perchero de pie, con cómodos soportes para los trajes. Puede estar provisto de anillo y cubeta paraguero. Cabeza en polímero técnico, barra en acero pintado, base en acero revestido en polímero técnico. Disponible acabado aluminio o negro opaco



1090. DOPPIOPETTO

appendiabiti da terra
coat stand

29.

kit portaombrelli per DOPPIOPETTO
umbrella stand kit for DOPPIOPETTO



AIUTO

design Raul Barbieri
e Giorgio Marianelli 1982

999. AIUTO
appendiabiti da terra
coat stand

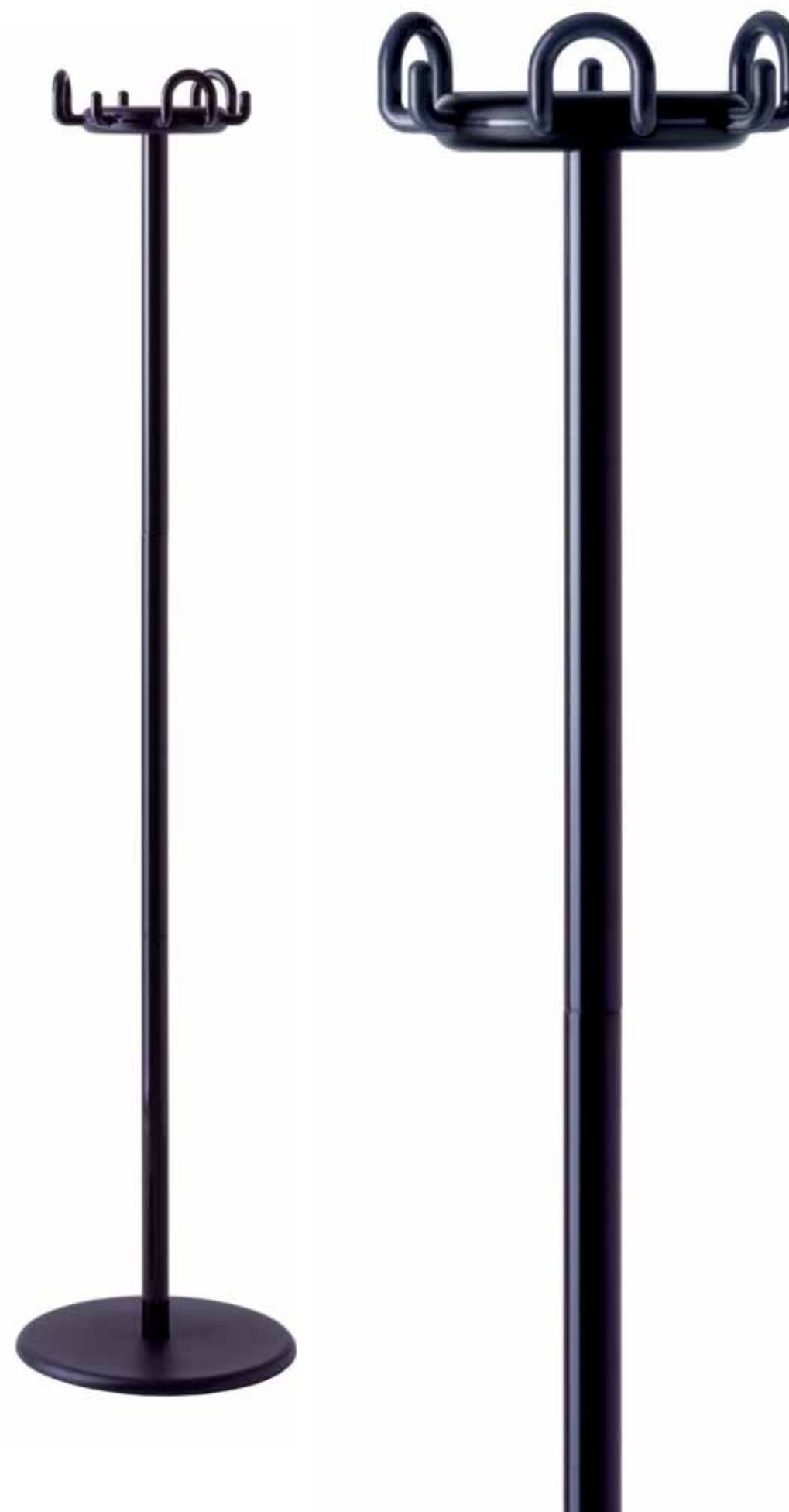

Appendiabiti da terra, pezzo storico ma sempre attuale, coordinato alla collezione Cribbio e ai ganci da parete UNDUETREPOSTI. Testa e ganci in polimero tecnico, asta in acciaio verniciato o cromato, base in acciaio rivestita in polimero tecnico. Proposto tutto nero, tutto alluminio o nero con ganci e asta cromati.

Classic yet always fashionable design coat stand matching both the Cribbio collection and the UNDUETREPOSTI wall coat hanger series. Head and hooks in engineering polymer, leg in varnished or chromium plated steel, steel base with engineering polymer cover. Versions include total black, total aluminium or black with chromium plated hooks and leg.

Un portemanteau sur pied, modèle historique, mais toujours actuel, combiné à la collection Cribbio et aux crochets muraux UNDUETREPOSTI. Tête et patères en polymère technique, tige en acier verni ou chromé, base en acier avec couverture en polymère technique. Proposé entièrement en noir, entièrement en aluminium ou noir avec crochets et tiges chromés.

Der Kleiderständer Aiuto ist ein historisches jedoch immer aktuelles Stück, passend zur Kollektion Cribbio und zu den Wandkleiderhaken UNDUETREPOSTI. Kopf und Haken aus Technischem-Polymer, Stange aus lackiertem oder verchromtem Stahl, Stahlsockel mit Technischem-Polymer Abdeckung. Erhältlich komplett schwarz oder komplett alufarbig und schwarz mit verchromten Haken und Stange.

Perchero de pie, pieza histórica pero siempre actual, combina con la colección Cribbio y con los ganchos de pared UNDUETREPOSTI. Cabeza y ganchos en polímero técnico, barra en acero pintado o cromado, base en acero revestido en polímero técnico. Disponible todo negro, todo aluminio o negro con ganchos y barra cromados.

999. AIUTO
appendiabiti da terra
coat stand

19.
kit portaombrelli per AIUTO
umbrella stand kit for AIUTO

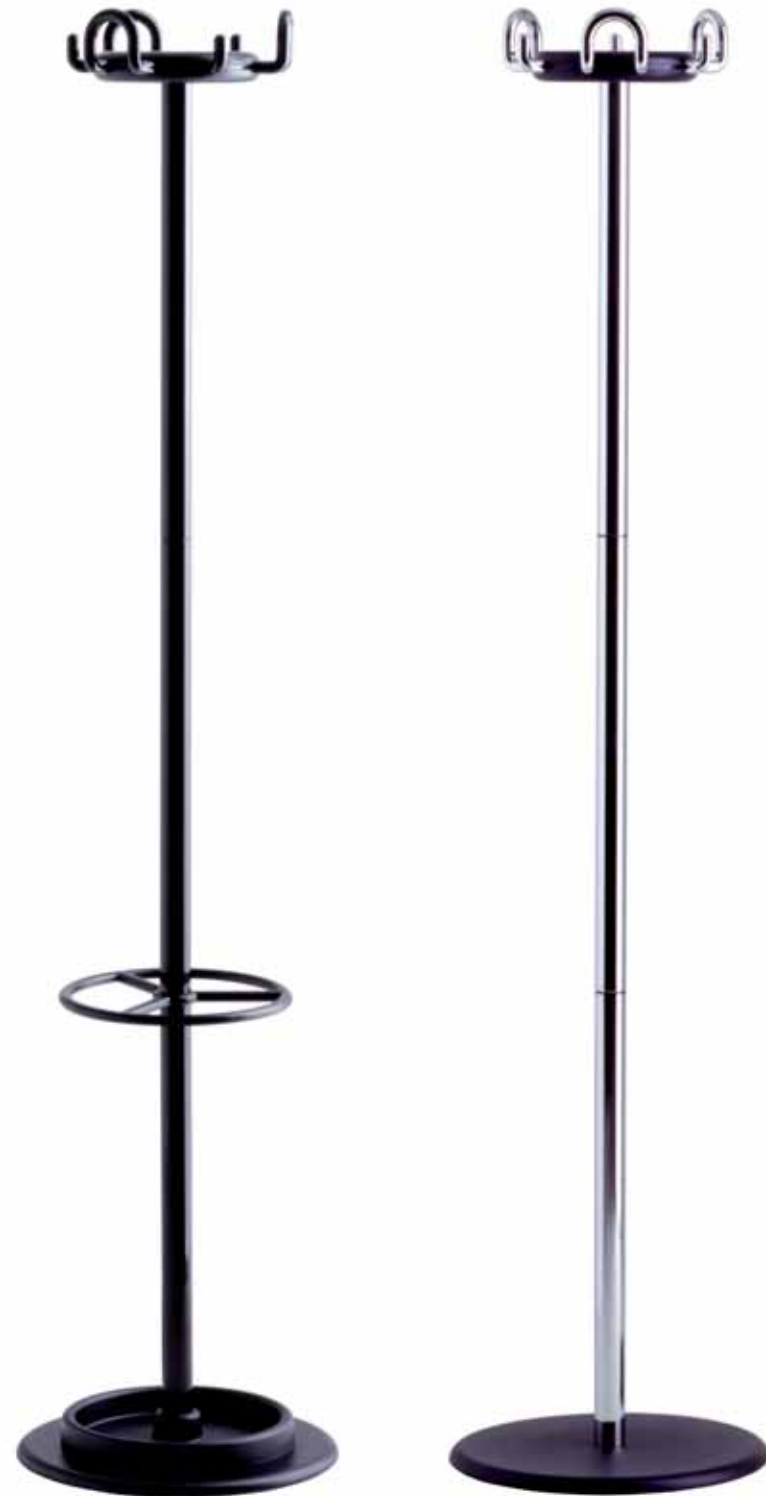

UNPOSTO DUEPOSTI TREPOSTI

design Raul Barbieri e Giorgio Marianelli 1986

Appendiabiti modulari da parete in polimero tecnico, in 3 modelli: singolo, a 2 posti, a 3 posti, che possono essere accostati per formare una barra continua con modulo di 15 cm. In nero o finitura alluminio.

Modular wall coat hangers in engineering polymer. 3 models available: single, 2 places and 3 places. All can be combined to create a continuous 15 cm (6") module rack. Black or aluminium finish.

Patères murales modulaires en polymère technique, en 3 modèles: simple, double, triple, pouvant être rapprochés pour former une barre continue de 15 cm. En noir ou finition aluminium.

Modul-Wandkleiderhaken aus Technischem-Polymer in 3 Modellen: Einzelhaken, Doppel- oder Tripelhaken, die mit Modul von 15 cm zu einer ununterbrochenen Leiste zusammengesetzt werden können. Schwarz oder alufarbig erhältlich.

Perchas modulares de pared en polímero técnico, en 3 modelos: individual, doble, triple, que se pueden juntar para formar una barra continua con módulos de 15 cm. En negro o acabado aluminio.

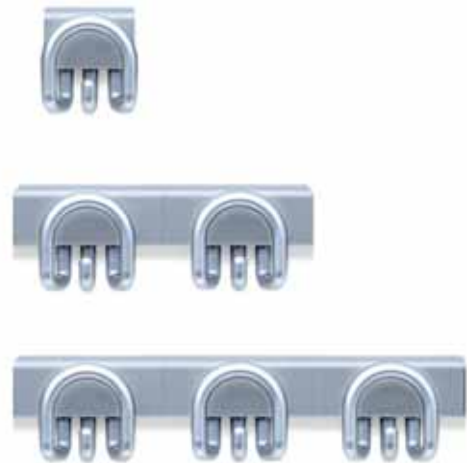

991. UNPOSTO
992. DUEPOSTI
993. TREPOSTI
 appendiabiti singolo-doppio-triplo da parete
 single-double-triple wall coat rack

NOX IPSO
design Raul Barbieri 2005

1635. NOX IPSO
appendiabiti da terra
coat stand





Caratterizzato dalla purezza del disegno, l'appendiabiti a stelo Nox Ipso è totalmente realizzato in acciaio inossidabile satinato. Dal nucleo centrale si dipartono i bracci, che terminano con quattro dischi perfetti.

Pure design for Nox Ipso coat stand, entirely realised in brushed stainless steel. Four arms, ending with four perfect discs, originate from the main body.

Caractérisé par la pureté de son dessin, le portemanteau sur pied Nox Ipso est entièrement réalisé en acier inoxydable satiné. D'une partie centrale se détachent 4 bras terminant par quatre disques parfaits.

Durch ein feines Design charakterisiert, wird der Kleiderständer Nox Ipso vollständig aus satiniertem Edelstahl realisiert. Vom Zentralkern teilen sich die Arme auf, die mit 4 perfekten Scheiben enden.

Characterizado por la pureza del diseño, el perchero de pie Nox Ipso está totalmente realizado en acero inoxidable satinado. Los brazos, que se dividen desde el núcleo central, terminan en 4 discos perfectos.

1635. NOX IPSO
appendiabiti da terra
coat stand

2501. OLIVIA
poltroncina impilabile
stackable armchair

988. APPUNTAMENTO
orologio a pendolo da parete
pendulum wall clock



NOX EGO
design Raul Barbieri 2010

1637. NOX EGO
appendiabiti da terra
coat stand



Appendiabiti a stelo caratterizzato dal disegno minimalista e dalle dimensioni contenute, totalmente realizzato in acciaio inossidabile satinato.

A minimalist design reduced-bulk coat stand, fully made of brushed stainless steel.

Un portemanteau sur pied caractérisé par son dessin minimaliste et ses dimensions réduites, entièrement réalisé en acier inoxydable satiné.

Kleiderständer, charakterisiert durch seine Minimaldesign und eingeschränkten Ausmaße, wird vollständig aus satiniertem Edelstahl realisiert.

Perchero de pie caracterizado por el minimalismo del diseño y por sus dimensiones contenidas, totalmente realizado en acero inoxidable satinado.



1637. NOX EGO
appendiabiti da terra
coat stand

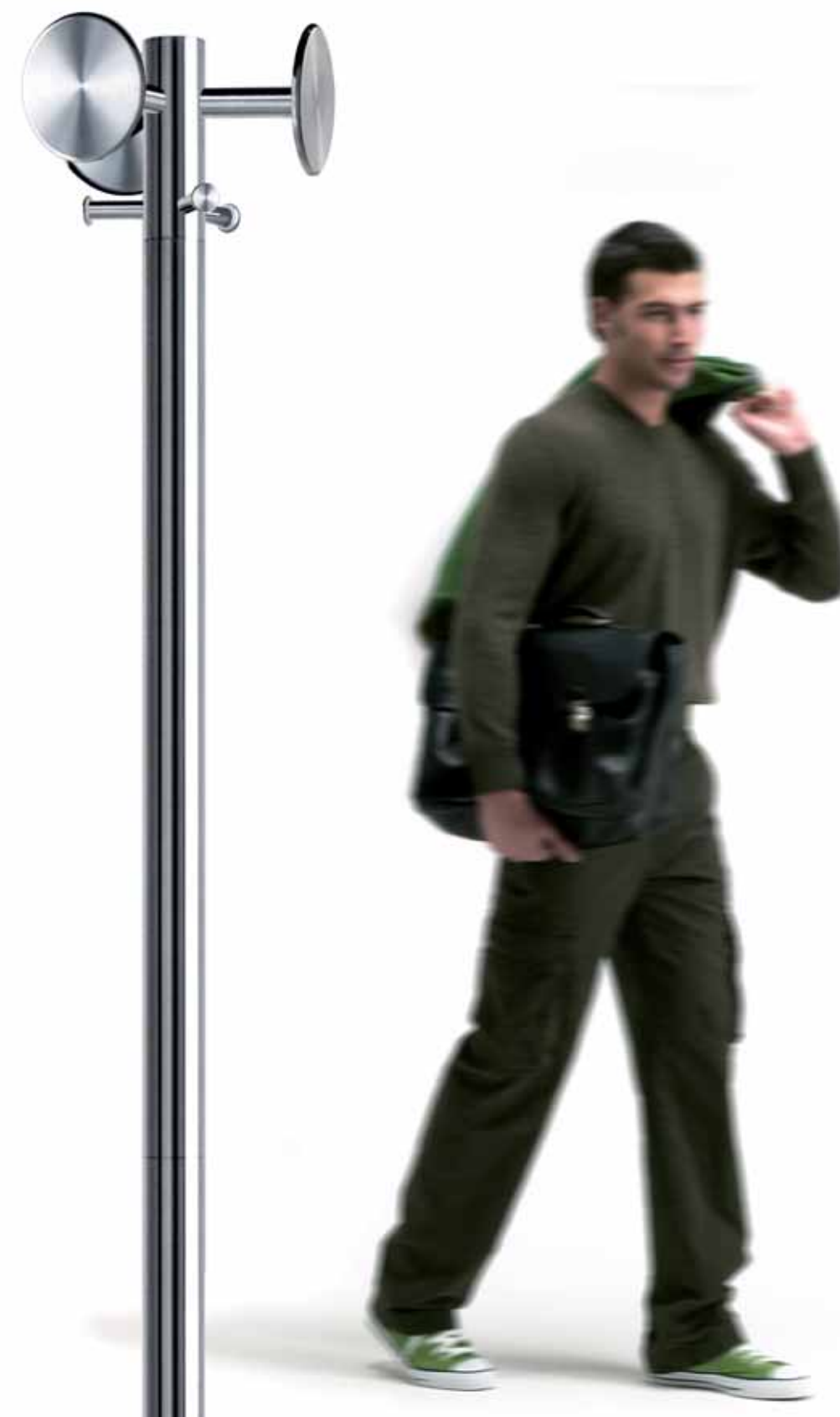



NOX VESTA WALL

design Raul Barbieri 2007

La collezione di appendiabiti in acciaio inossidabile satinato della linea Nox prevede anche un sistema da parete composto da due modelli, a 3 e 6 posti, che possono essere combinati senza limitazioni.

The Nox brushed stainless steel coat stand collection also includes a wall system featuring two version, 3 and 6 places, for unlimited combinations.

La collection de portemanteaux en acier inoxydable satiné de la ligne Nox prévoit aussi un système mural, composé de deux modèles, à 3 ou 6 emplacements, pouvant être combiné sans limitations.

Die Kollektion der NOX Kleiderständer aus satiniertem Edelstahl sieht außerdem ein Wandsystem vor, mit zwei Modellen von 3 und 6 Plätzen, die grenzenlos miteinander zusammengesetzt werden können.

La colección de percheros en acero inoxidable satinado de la línea Nox dispone también de un sistema de pared, compuesto por dos modelos, de 3 y 6 plazas, que se pueden combinar sin límites.

1650. NOX VESTA
appendiabiti da parete
wall coat hanger



CRIBBIO

design Raul Barbieri
e Giorgio Marianelli 1982

1010. CRIBBIO
portaombrelli / cestino alto
umbrella stand / tall waste basket



Cribbio, disegnata nel 1981, è la storica famiglia di cestini gettacarte e portaombrelli realizzati senza alcuna saldatura da un unico foglio di acciaio imbutito e poi traforato radialmente. Nel tempo si sono aggiunti l'appendiabiti con portaombrelli e il posacenere da terra. Una collezione che si distingue per la solidità, la leggerezza e la cura dei particolari, coordinata al set da scrivania Babele (1980). Finiture in alluminio, nero, nero con particolari cromati.

The 1981 designed Cribbio collection is a historic series of waste-paper baskets and umbrella stands. Made without weldings, from a single sheet of drawn and radial edge perforated steel. It has gradually been enriched with coat stands and standing ashtrays. The collection features high solidity, lightness, superior attention to detail, and fits the Babele desktop set (1980). Aluminium, black or black with chromium plated detail finishes.

Cribbio, dessinée en 1981, constitue la famille historique des corbeilles et des porte-parapluies réalisés sans la moindre soudure à partir d'une seule feuille d'acier embouti et ensuite percée radialement. Au fil des années, on y a ajouté le portemanteau avec porte-parapluie et le cendrier sur pied. Une collection caractérisée par sa solidité, sa légèreté et le soin des détails, assortie à l'ensemble de bureau Babele (1980). Finitions en aluminium, noir, noir aux détails chromés.

Cribbio, die im 1981 gezeichnet wurde, ist die historische Familie der Papierkörbe und Schirmständer ohne Schweissnähte. Die Behälter werden mit einem Tiefziehstahlblatt realisiert und dann radial gelocht. Mit der Zeit wurden Kleiderständer mit Schirmständern und Standascher hinzugefügt. Eine Kollektion, die sich durch die Solidität, die Leichtigkeit und die Pflege im Detail unterscheiden, ist mit dem Schreibtisch-Set Babele (1980) kombiniert. Erhältlich in schwarz, alufarbig oder schwarz mit verchromten Details.

Cribbio, diseñada en 1981, es la histórica familia de papeleras y paragueros realizados sin ninguna soldadura, con una única hoja de acero embutido y posteriormente perforado radialmente. Con el tiempo se han añadido el perchero con paraguero y el cenicero de pie. Una colección que se distingue por la solidez, la ligereza y el cuidado en los detalles, a juego con el set de escritorio Babele (1980). Acabados en aluminio, negro, negro con detalles cromados.

1000. CRIBBIO
cestino gettacarte waste basket

1010. CRIBBIO
portaombrelli / cestino alto
umbrella stand / tall waste basket

1020. CRIBBIO
posacenere da terra con gettacarte
combination floor ashtray and waste basket

1030. CRIBBIO
appendiabiti da terra
con portaombrelli
combination coat and umbrella stand

999. AIUTO
appendiabiti da terra
coat stand

15.
vaschetta ecologica
ecology cup





940. BABELE
vaschetta portacorrispondenza
letter tray

930. CENTOBUCHI
barattolo portamatite
pencil cup

1000. CRIBBIO
cestino gettacarte
waste basket

1030. CRIBBIO
appendiabiti da terra con portaombrelli
combination coat and umbrella stand

987. CONTRATTEMPO
orologio a pendolo da parete
pendulum wall clock

COLMO

design Raul Barbieri
e Giorgio Marianelli 2003

1051. COLMO
portaombrelli / cestino alto
umbrella stand / tall waste basket

1052. COLMO
posacenere da terra con gettacarte
combination floor ashtray and waste basket



La collezione comprende cestino gettacarte, portaombrelli, appendiabiti con portaombrelli e posacenere da terra. Come per Cribbio, i contenitori sono realizzati senza alcuna saldatura da un unico foglio di acciaio imbutito. Finiture in alluminio, nero, nero con particolari cromati.

The collection includes waste-paper baskets, umbrella stands, coat stands with umbrella stands and standing ashtrays. Like Cribbio, the containers are made without weldings, from a single sheet of drawn steel. Finishes in aluminium, black, black with chromium plated detail finishes.

La collection comprend une corbeille, un porte-parapluie, un portemanteau avec porte-parapluie et un cendrier sur pied. Comme pour Cribbio, les conteneurs sont réalisés sans la moindre soudure à partir d'une seule feuille d'acier emboutie. Finitions en aluminium, noir, noir aux détails chromés.

Die Kollektion besteht aus Papierkörben, Schirmständern, Kleiderständern mit Schirmständern und Standascher. Wie für Cribbio, werden die Behälter mit einem Tiefziehstahlblatt, ohne Schweissnähte, realisiert. Erhältlich in schwarz, alufarbig oder schwarz mit verchromten Details.

La colección comprende papeleras, paragüeros, percheros con paragüero y ceniceros de pie. Como en el caso de Cribbio, los contenedores están realizados sin ninguna soldadura con una única hoja de acero embutido. Acabados en aluminio, negro, negro con detalles cromados.

1050. COLMO
cestino gettacarte
waste basket

1051. COLMO
portaombrelli / cestino alto
umbrella stand / tall waste basket

1052. COLMO
posacenere da terra con gettacarte
combination floor ashtray and waste basket

1053. COLMO
appendiabiti da terra con portaombrelli
combination coat and umbrella stand

15.
vaschetta ecologica
ecology cup



BIRILLO

design Giotto Stoppino 1982

1200. BIRILLO
portaombrelli / posacenere da terra
umbrella stand / floor ashtray



Collezione di cestini gettacarte, portaombrelli e posacenere da terra dalla linea classica, caratterizzata dal bordo superiore arrotondato. Realizzata in polimero tecnico, è disponibile in nero o finitura alluminio. Il portaombrelli può essere dotato di vaschetta posacenere con o senza griglia in acciaio verniciato nero o cromato.

Series of classic design waste-paper baskets, umbrella stands, and standing ashtrays, featuring rounded upper edge. Made in engineering polymer and available in black or aluminium finishes.

The umbrella stand may come with ashtray with or without grille, in black or chromium plated painted steel.

Collection de corbeilles, de porte-parapluies et de cendriers sur pied selon une ligne classique, caractérisée par le bord supérieur arrondi. Réalisée en polymère technique, elle est disponible en noir et finition aluminium. Le porte-parapluie peut être fourni avec cendrier avec ou sans grille en acier verni noir ou chromé.

Kollektion bestehend aus Papierkörben, Schirmständern und Standascher von klassischer Linie, charakterisiert durch den oberen abgerundeten Rand. Die Behälter sind aus Technischem-Polymer, schwarz oder alufarbig.

Der Schirmständer kann mit einer Aschenschale, mit oder ohne Sieb, aus schwarz lackiertem oder verchromtem Stahl ausgestattet werden.

Colección de papeleras, paragüeros y ceniceros de pie con una línea clásica, caracterizada por el borde superior redondeado. Realizada en polímero técnico, está disponible en negro o acabado en aluminio.

El paragüero puede estar dotado de cenicero con o sin rejilla en acero pintado negro o cromado.

1100. BIRILLO

cestino gettacarte
waste basket

1200. BIRILLO

cestino alto / posacenere da terra
tall waste basket / floor ashtray



BIRILLO PLUS

design Giotto Stoppino 2004

Nella versione Plus il corpo del cestino è senza fondo, per accogliere all'interno un contenitore in metallo da cui sarà facile estrarre e svuotare il sacchetto porta rifiuti, che però resterà sempre invisibile.

In the Plus version, the main body of the basket is baseless, and a metallic container is included inside. From this container one can easily remove and empty a waste bag, that will not be visible.

Dans la version Plus, le corps de la corbeille est sans fond, pour accueillir à l'intérieur un conteneur en métal permettant aisément d'extraire et vider le sac poubelle qui restera néanmoins toujours invisible.

In der Birillo Plus Version ist der Papierkorb ohne Boden, um einen inneren Metallbehälter zu enthalten, der mit einem leicht leerbaren im Papierkorb unsichtbaren Beutel versehen werden kann.

En la versión Plus el cuerpo de la papelera no tiene fondo, para poder colocar en su interior un contenedor de metal del que será fácil extraer y vaciar una bolsa de basura, que, sin embargo, siempre permanecerá invisible.



1102. BIRILLO PLUS
cestino gettacarte
waste basket

1202. BIRILLO PLUS
cestino alto / portaombrelli
tall waste basket / umbrella stand

STATUS

design Raul Barbieri 1991

1440. STATUS
portaombrelli / cestino alto
umbrella stand / tall waste basket



Una collezione per uffici direzionali, coordinata all'omonimo set da scrivania. Cestini gettacarte e portaombrelli dalla linea personale e rigorosa, in polimero tecnico verniciato nero opaco o finitura alluminio. I contenitori possono essere dotati di anello copri-sacchetto o di anello con coperchio basculante.

A series designed for executive offices, fitting the desktop set of the same name. Personal and sober style waste-paper baskets and umbrella stands, in mat black or aluminium finish painted engineering polymer. The containers may come with bag-cover ring or ring with flip top lid.

Une collection destinée aux bureaux de direction, avec son ensemble de bureau du même nom. Des corbeilles et des porte-parapluies à la ligne personnelle et rigoureuse, en polymère technique verni noir mat ou finition aluminium. Les conteneurs peuvent être fournis avec un anneau couvre-sac ou un anneau avec couvercle basculant.

Eine Kollektion für Direktionsbüros, die mit dem gleichnamigen Schreibtisch-Set kombiniert ist. Papierkörbe und Schirmständer von personeller und rigoroser Linie, aus Technischem-Polymer, alufarbig oder mattschwarz lackiert. Die Behälter können mit einem Abfallsack-Abdeckring oder mit einem Ring mit Schwingdeckel ausgestattet werden.

Una colección para oficinas de dirección, a juego con el homónimo set de escritorio. Papeleras y paragueros con una línea personal y rigurosa, en polímero técnico pintado negro opaco o acabado aluminio. Los contenedores pueden estar dotados de anillo cubre-bolsa o de anillo con tapa basculante.

1400. STATUS

cestino gettacarte
waste basket

1440. STATUS

portaombrelli / cestino alto
umbrella stand / tall waste basket

20.

anello coprisacchetto
bag cover ring

21.

anello con coperchio basculante
ring with flip top lid





- 332. STATUS**
barattolo portamatite
pencil cup
- 350. STATUS**
vaschetta portacorrispondenza
letter tray
- 1400. STATUS**
cestino gettacarte
waste basket
- 1440. STATUS**
portaombrelli / cestino alto
umbrella stand / tall waste basket
- 987. ORARIO**
orologio da parete
wall clock

TABOO

design Raul Barbieri 2008



1460. TABOO
cestino gettacarte
waste basket

18.
vaschetta ecologica
ecology cup

Caratteristica di questo cestino gettacarte dalla forte personalità è la maniglia, allo stesso tempo dettaglio estetico oltre che funzionale. Al cestino è coordinata la vaschetta ecologica, destinata alla raccolta differenziata dei rifiuti, dotata di un'analogia maniglia che ne permette il posizionamento sia all'interno che all'esterno del cestino. Sono realizzati in polimero tecnico in vari colori o con finitura alluminio.

This strong-self waste-paper basket features a decorative as well as effective handle. The basket comes with an eco-friendly cup for different types of waste, which may be fixed inside or outside the basket through a similar handle. Made in engineering polymer, available in several colours or aluminium finish.

La caractéristique de cette corbeille, à la forte personnalité, est sa poignée qui est, en même temps, détail esthétique et fonctionnel. La corbeille est fournie avec une coupe écologique destiné au tri sélectif des déchets, qui possède la même poignée permettant son positionnement à l'intérieur et à l'extérieur de la corbeille. Ils sont réalisés en polymère technique en plusieurs coloris ou avec finition aluminium.

Die Charakteristik dieses Papierkorbs, von einer starken Persönlichkeit, ist der Griff, der nicht nur ein ästhetisches sondern auch ein funktionelles Detail ist. Der Papierkorb kann mit einem umweltfreundlichen Schale für die getrennte Müllsammlung, mit gleichem Griff, ausgestattet werden und der Schale kann innerhalb oder außerhalb des Papierkorbs gestellt werden. Papierkorb und Schale werden aus Technischem-Polymer in verschiedenen Farben oder alufarbig realisiert.

La característica de esta papelera con fuerte personalidad es la manilla, que es, al mismo tiempo, detalle estético y funcional. La papelera combina con la cubeta ecológica, destinada al reciclaje de la basura, dotada de una manilla similar que permite su colocación ya sea dentro que fuera de la papelera. Están realizados en polímero técnico en varios colores o acabado aluminio.



1460. TABOO
cestino gettacarte
waste basket
18.
vaschetta ecologica
ecology cup

ECO
design Raul Barbieri 1993



1500.ECO
cestino gettacarte
waste basket

16.
vaschetta ecologica
ecology cup

17.
anello coprisacchetto
bag cover ring

Disegnato nel 1992, è una perfetta sintesi di personalità e sobrietà. E' realizzato in polimero tecnico in vari colori o finitura alluminio e può essere dotato sia di una vaschetta per la raccolta differenziata che di un anello coprisacchetto che di un anello coprisacchetto neri o con finitura alluminio.

Designed in 1992, it is an excellent combination of self and simplicity. Made in engineering polymer in several colours or aluminium finish. It may come with an eco-friendly cup for different types of waste and a bag-covering ring, both either black or with aluminium finish.

Dessiné en 1992, il s'agit d'une synthèse parfaite entre personnalité et sobriété. Elle est réalisée en polymère technique en différents coloris ou finition aluminium et peut être fournie avec une coupe écologique destinée au tri sélectif des déchets et avec un anneau couvre-sac noirs ou finition aluminium.

Im 1992 gezeichnet, Eco ist eine perfekte Vereinigung der Persönlichkeit und Schlichtheit. Er wird aus Technischem-Polymer in verschiedenen Farben oder alufarbig realisiert und kann mit einem umweltfreundlichen Schale für die getrennte Müllsammlung und mit einem Abfallsack-Abdeckring ausgestattet werden.

Diseñado en 1992, es una síntesis perfecta de personalidad y sobriedad. Está realizado en polímero técnico en varios colores o acabado aluminio y puede estar dotado tanto de una cubeta para el reciclaje como de un anillo cubre-bolsa negro o acabados aluminio.



1500. ECO
cestino gettacarte
waste basket

16.
vaschetta ecologica
ecology cup

17.
anello coprisacchetto
bag cover ring



ECO PRO

design Raul Barbieri 1993

Eco è proposto anche nella versione Eco Pro, realizzata in polipropilene e valorizzata dalla delicatezza dei colori traslucidi: bianco, verde, blu, arancio, abbinati a vaschetta e anello bianchi traslucidi.

Eco is also available in the Eco Pro version, made in polypropylene and enhanced in soft translucent colours: white, green, blue, orange, with frosted white cup and ring.

Eco est proposée aussi dans la version Eco Pro, réalisée en polypropylène et mise en valeur par la délicatesse des couleurs translucides: blanc, vert, bleu, orange, assorties aux coupe et anneau blanc translucides.

Eco ist auch in der Ausführung Eco Pro erhältlich, aus Polypropylen. Diese Ausführung wird durch die Feinheit der transparenten Farben weiß, grün, blau, orange, kombiniert mit der transparenten weißen Schale und Ring aufgewertet.

Eco se encuentra también en la versión Eco Pro, realizada en polipropileno y valorada por la delicadeza de los colores traslúcidos: blanco, verde, azul, naranja, combinados con la cubeta y el anillo en blanco translúcido.



1500. ECO PRO
cestino gettacarte
waste basket

16.
vaschetta ecologica
ecology cup

17.
anello coprisacchetto
bag cover ring





NOX

design Raul Barbieri 2002



1613. NOX
posacenere da terra con cestino / portaombrelli
floor ashtray with basket / umbrella stand



Una collezione di contenitori accomunati dalla linea minimale e dal prestigio dell'acciaio inossidabile, destinati ad una molteplicità di funzioni: cestini gettacarte, cestini alti, portaombrelli, posacenere da terra, cestini e posacenere da parete, fioriere, tutti realizzati in acciaio inossidabile AISI 304 da 0,8 mm satinato, con saldature invisibili, bordi arrotondati antinfortunistici e guarnizioni salva-pavimento.

A series of minimalist design containers in stainless steel, suitable for several uses: waste-paper baskets, high baskets, umbrella stands, standing ashtrays, wall baskets and ashtrays, planters. All made in brushed 0,8 mm AISI 304 stainless steel, with invisible weldings, rounded safety edges and floor protection in rubber.

Une collection de conteneurs caractérisés par leur ligne essentielle et par le prestige de l'acier inoxydable, destinés à plusieurs usages: corbeilles, corbeilles hautes, porte-parapluies, cendriers sur pied, corbeilles et cendriers muraux, cache-pots, tous réalisés en acier inoxydable AISI 304 de 0,8 mm satiné, avec soudures invisibles, bords arrondis non coupants et garnitures protège sol en caoutchouc.

Nox ist eine Kollektion von Behältern mit einer minimalen Linie und mit dem Prestige des Edelstahls, die für vielseitige Zwecke bestimmt sind. Die Papierkörbe, Hohe Papierkörbe, Schirmständer, Standascher, Wand-Papierkörbe und Aschenschale und die Blumenwannen sind alle aus 0,8 mm satiniertem Edelstahl AISI 304 mit unsichtbaren Schweißnähten, unfallsicheren abgerundeten Ränder und gummierter Fußbodenschutz.

Una colección de contenedores acomodados por una línea minimalista y por el prestigio del acero inoxidable, destinados a una multiplicidad de funciones: papeleras, papeleras altas, paragüeros, ceniceros de pie, papeleras y ceniceros de pared, maceteros, todos ellos realizados en acero inoxidable AISI 304 de 8 mm satinado, con línea de soldadura invisible, bordes redondeados y protector de suelos en goma.



1613. NOX
posacenere da terra con cestino / portaombrelli
floor ashtray with basket / umbrella stand



986. ORARIO INOX
orologio da parete
wall clock





1615. NOX
posacenere da terra con cestino /portaombrelli
floor ashtray with basket/umbrella stand

1621. NOX
posacenere a stelo
standing ashtray



NOX WALL

design Raul Barbieri 2005

Cestini e posacenere da parete dotati di fissaggio antifurto, realizzati in acciaio inossidabile AISI 304 da 0,8 mm satinato, con saldature invisibili e bordi arrotondati antinfortunio. Sono in perfetto abbinamento con gli appendiabiti e le fioriere della collezione NOX.

Wall baskets and ashtrays with antitheft fixing, in brushed 0,8 mm AISI 304 stainless steel, with invisible weldings and rounded safety edges. They fit perfectly the NOX collection coat stands and planters.

Corbeilles et cendriers muraux pourvus de fixations antivols, réalisés en acier inoxydable AISI 304 de 0,8 mm satiné, avec soudures invisibles et bords arrondis non coupants. Ils sont parfaitement assortis aux portemanteaux et aux cache-pots de la collection NOX.

Die diebstahlgesicherte Wand-Papierkörbe und Aschenschale werden aus 0,8 mm satiniertem Edelstahl AISI 304 mit unsichtbaren Schweißnähten und unfallsicheren abgerundeten Ränder realisiert. Sie sind perfekt mit den Kleiderständern und Blumenwannen der NOX Kollektion kombiniert.

Papeleras y ceniceros de pared dotados de fijación antirobo, realizados en acero inoxidable AISI 304 de 8 mm satinado, con línea de soldadura invisible y bordes redondeados. Combinan perfectamente con los percheros y los maceteros de la colección NOX.

1626. 1629. NOX WALL

posacenere e cestino da parete con fissaggio antifurto
wall ashtray and waste basket with anti-theft fixing

1688. NOX FLORA

fioriera su ruote
planter on castors

1635. NOX IPSO

appendiabiti da terra
coat stand

NOX MAGNUM

design Raul Barbieri 2004

Straordinario contenitore king-size con altezza 76 cm e diametro 38 cm in acciaio inossidabile AISI 304 da 0,8 mm satinato, con saldature invisibili e bordi arrotondati antinfortunistico. Può essere equipaggiato sia da un coperchio basculante che da un coperchio antifiama.

Outstanding king-size container, 76 cm high, 38 cm diameter (h 30 ø 15"). Made in brushed 0,8 mm AISI 304 stainless steel, with invisible weldings and rounded safety edges. It may come with a flip top or an anti-flame lid.

Extraordinaire conteneur king-size d'une hauteur de 76 cm et d'un diamètre de 38 cm en acier inoxydable AISI 304 de 0,8 mm satiné, avec soudures invisibles, bords arrondis non coupants. Il peut être équipé d'un couvercle basculant ou d'un couvercle anti-flamme.

Ein herrlicher, 76 cm hoher Behälter mit Durchmesser von 38 cm, aus 0,8 mm satiniertem Edelstahl AISI 304 mit unsichtbaren Schweißnähten und unfallsicheren abgerundeten Ränder. Er kann mit einem Schwingdeckel oder mit einem selbstlöschenden Deckel ausgestattet werden.

Extraordinario contenedor king-size con 76 cm de altura y 38 cm de diámetro en acero inoxidable AISI 304 de 8 mm satinado, con línea de soldadura invisible y bordes redondeados. Se puede equipar tanto por una tapa basculante como por una tapa antillama.

1667. NOX MAGNUM

contenitore con coperchio basculante
container with flip top lid

2210. ZANZIBAR

sgabello ad altezza regolabile
stool with adjustable height





1665. NOX MAGNUM
 contenitore
 container

1668. NOX MAGNUM
 contenitore con supporto per sacchetti
 e coperchio spegnifiamma
 container with bag holder
 and flame choking lid

1603. NOX
 cestino con supporto per sacchetti
 e coperchio spegnifiamma
 waste basket with bag holder
 and flame choking lid

2265. WELCOME
 sgabello ad altezza regolabile su ruote
 stool with adjustable height on castors





NOX FLORA
design Raul Barbieri 2004

Le fioriere Nox Flora, proposte in 3 dimensioni, sono realizzate interamente in acciaio inossidabile AISI 304 da 0,8 mm satinato; sono dotate di sottovaso interno in polipropilene e di ruote per facilitarne lo spostamento.

The Nox Flora planters, in 3 dimensions, are fully made in brushed 0,8 mm AISI 304 stainless steel. They come with internal pot dish in polypropylene and wheels to make it easily movable.

Les cache-pots Nox Flora, proposées en 3 dimensions, sont entièrement réalisées en acier inoxydable AISI 304 de 0,8 mm satiné; elles sont équipées d'un sous-pot interne en polypropylène et de roulettes pour en faciliter la manutention.

Die in 3 Größen Blumenwannen Nox Flora sind vollständig aus 0,8 mm satiniertem Edelstahl AISI 304 hergestellt. Sie sind mit einem inneren Untersetzer aus Polypropylen und mit Rollen für ein leichtes Verschieben ausgestattet.

Los maceteros Nox Flora, que se encuentran en 3 dimensiones, están realizados completamente en acero inoxidable AISI 304 de 8 mm satinado; están dotados de plato interno en polipropileno y de ruedas para facilitar su desplazamiento.

NOX VESTA
design Raul Barbieri 2005

1641. NOX VESTA
appendiabiti lineare su ruote con cappelliera
coat rail on castors with hat rack



La collezione di appendiabiti a barra su ruote Nox Vesta in acciaio inossidabile AISI 304 satinato si articola in quattro versioni: al modello base dotato di semplice barra appendi grucce si affiancano altri 3 modelli dotati rispettivamente di supporto inferiore per borse, di cappelliera, e di cappelliera e supporto borse. Dedicati sia alla collettività che agli uffici e alla casa, sono disponibili in due lunghezze, 120 cm e 160 cm.

The Nox Vesta collection of coat rails on castors is in brushed AISI 304 stainless steel. It comes in four versions: base model with bar for clothes hangers and 3 other models featuring bottom bag rack, hat rack, and hat & bag racks, respectively. This series suits community as well as offices and private houses. Available in two lengths, 120 cm and 160 cm (47^{1/4} and 62").

La collection de portemanteaux à barre sur roulettes Nox Vesta en acier inoxydable AISI 304 satiné est proposée en quatre versions: un modèle base avec une simple barre porte cintres et 3 autres modèles pourvus respectivement d'un support inférieur, d'un support supérieur, et d'un support supérieur et inférieur. Destinés aux espaces communs, aux bureaux ou à un usage domestique, ils sont disponibles en deux longueurs: 120 cm et 160 cm.

Die Kollektion der Kleiderbügelständern auf Rollen Nox Vesta, aus satiniertem Edelstahl AISI 304, gliedert sich auf vier Versionen. Am Grundmodell, bestehend aus einer einfachen Kleiderbügelstange, kommen weitere 3 Modelle hinzu: mit unterer Taschenablage, mit Hutablage, mit Taschen- und Hutaablage. Geeignet sowohl für das Büro als auch für die Wohnung, sind in zwei Längen erhältlich: 120 cm und 160 cm.

La colección de percheros a barra sobre ruedas Nox Vesta en acero inoxidable AISI 304 satinado se propone en cuatro versiones: al modelo básico dotado de una simple barra para colgar las perchas se unen otros 3 modelos, respectivamente con soporte inferior para bolsas, con sombrerero, y con sombrerero y soporte para bolsas. Dedicados tanto a la colectividad como a las oficinas o a la casa. Disponible en dos tamaños, 120 cm y 160 cm.

1643. NOX VESTA

appendiabiti lineare su ruote con cappelliera e griglia portaborse
coat rail on castors with hat and bag racks

1641. NOX VESTA

appendiabiti lineare su ruote con cappelliera
coat rail on castors with hat rack

1640. NOX VESTA

appendiabiti lineare su ruote
coat rail on castors





1641. NOX VESTA
 appendiabiti lineare su ruote
 con cappelliera
 coat rail on castors with hat rack

2210. ZANZIBAR
 sgabello ad altezza regolabile
 stool with adjustable height

1690. NOX
 posacenere per tavoli conferenze
 large executive ashtray



1643. NOX VESTA
 appendiabiti lineare su ruote con cappelliera
 e griglia porta-borse
 coat rail on castors with hat and bag racks

1667. NOX MAGNUM
 contenitore con coperchio basculante
 container with flip top lid

2506. OLIVIA
 sgabello medio
 kitchen stool

NOX VESTA WALL

design Raul Barbieri 2007

Un'elegante barra da parete in acciaio inossidabile satinato su cui si innestano dischi e ganci dal disegno minimalista. I due modelli, da 3 e 6 posti, con lunghezza rispettivamente 48 cm e 96 cm si possono comporre secondo le esigenze e si integrano perfettamente con gli appendiabiti Nox Ego e Nox Ipsy, della stessa linea.

Elegant hanging rail in brushed stainless steel to which simple design discs and hooks are fixed. The two models, for 3 and 6, are 48 cm and 96 cm (19 and 38") long respectively. They may be assembled according to one's needs, and fully fit Nox Ego and Nox Ipsy coat stands of the same series.

Une élégante barre murale en acier inoxydable AISI 304 satiné où l'on trouve des disques et des patères au dessin essentiel. Les deux modèles, de 3 et 6 emplacements, avec une longueur allant de 48 cm à 96 cm peuvent être composés selon les exigences et ils s'intègrent parfaitement aux portemanteaux Nox Ego et Nox Ipsy, de la même ligne.

Eine elegante Schiene aus satiniertem Edelstahl AISI 304, wo Scheiben und Haken von einem Minimaldesign eingefasst sind. Die zwei Modelle von 3 bzw. 6 Plätzen mit einer Länge von 48 bzw. 96 cm, können je nach Bedarf zusammengebaut werden und integrieren sich perfekt mit den Kleiderständern Nox Ego und Nox Ipsy von gleicher Linie.

Una elegante barra de pared en acero inoxidable AISI 304 satinado sobre la que se encajan discos y ganchos con un diseño minimalista. Los dos modelos, de 3 y 6 plazas, con un tamaño de 48 cm y 96 cm respectivamente, se pueden componer según las necesidades y combinan perfectamente con los percheros Nox Ego y Nox Ipsy, de la misma línea.

1650. NOX VESTA WALLappendiabiti da parete
wall coat hanger**1637. NOX EGO**appendiabiti da terra
coat stand**1655. NOX MAGNUM**contenitore
container



Cherica

MARCO
+
MARILENE

Ja...
Leticia
Vanessa
Lara
Lara

ROSA
+
MARC

PAO
+
ANAP

BERNARDO
+
CARIELA
+
SEMPRE

STEVEN

ALEX
+
TAM

Leyva
+
Te amo

CURRO
+
TE QUERO
+
MUCHO!!!

Te amo
+
MUCHO!!!

Milly
+
KAROL
+
MARC

ANNE
+
1988

1
+
H

FABIANON

FRAN

Valencia

Rene

SELA

LARA

JEN

COA

VIEW

CLAUDIA E ROBERTO
PER SEMPRE

WIFI

PAO

216

CLAYTON

STATUS

design Raul Barbieri 1990

350.STATUS
vaschetta portacorrispondenza
letter tray



Collezione da scrivania per uffici direzionali, coordinata all'omonima collezione da terra. Il sofisticato minimalismo del disegno si abbina ad una scelta di materiali di pregio: alluminio pressofuso per il bicchiere portamatite e il porta-memo, polimero tecnico di elevato spessore per la vaschetta porta corrispondenza in finitura alluminio. Un grande sottomano e un piccolo sottomano con segnaposto per tavoli conferenze, ambedue in poliuretano nero, completano la collezione.

Desktop collection for executive offices, fitting the series of standing items of the same name. Sophisticated minimalist design combines with quality material: pencil cup and memo pad holder in die-cast aluminium, letter tray in thick engineering polymer with aluminium finish. The collection also includes a large desk pad and a small desk pad with name holder for conference tables, both in black polyurethane.

Ensemble de bureau pour bureaux de direction, assortie à la collection sur pied du même nom. L'essentialité sophistiqué du dessin est parfaitement assorti au matières précieuses: aluminium moulé sous pression pour le pot à crayons et le porte-mémo, polymère technique très épais pour la corbeille à courrier en finition aluminium. Cette collection est complétée par un grand sous-main et un petit sous-main avec porte-nom pour tables de conférences, tous deux en polyuréthane noir.

Eine Kollektion für die Direktionsschreibtische, kombiniert mit der gleichnamigen Bodenkollektion. Das erlesene Minimaldesign kombiniert sich mit der Wahl der renommierten Materialien: Aluminium-Spritzguss für den Stiftköcher und Zettelbox und alufarbiges Technisches Polymer für die Briefablagen. Vervollständigen die Kollektion eine große Schreibunterlage und eine kleine mit Platzkarte für den Konferenztisch, beide aus schwarzem Polyurethan-Intergralschaum.

Set para escritorios de dirección, a juego con la homónima colección de pie. El sofisticado minimalismo del diseño se combina con una elección de materiales de valor: aluminio moldeado a presión para el cubilete portaplumas y el porta-notas, polímero técnico de elevado espesor para la bandeja portacorrespondencia acabada aluminio. Un gran vade sobremesa y uno pequeño con marcador de lugar para mesas de conferencia, ambas en poliuretano negro, completan la colección.



- 303. STATUS**
sottomano con segnaposto
per tavoli conferenze
conference desk pad
with name holder
- 300. STATUS**
sottomano
desk pad
- 332. STATUS**
barattolo portamatite
pencil cup
- 340. STATUS**
portamemo
memo pad holder
- 350. STATUS**
vaschetta portacorrespondenza
letter tray

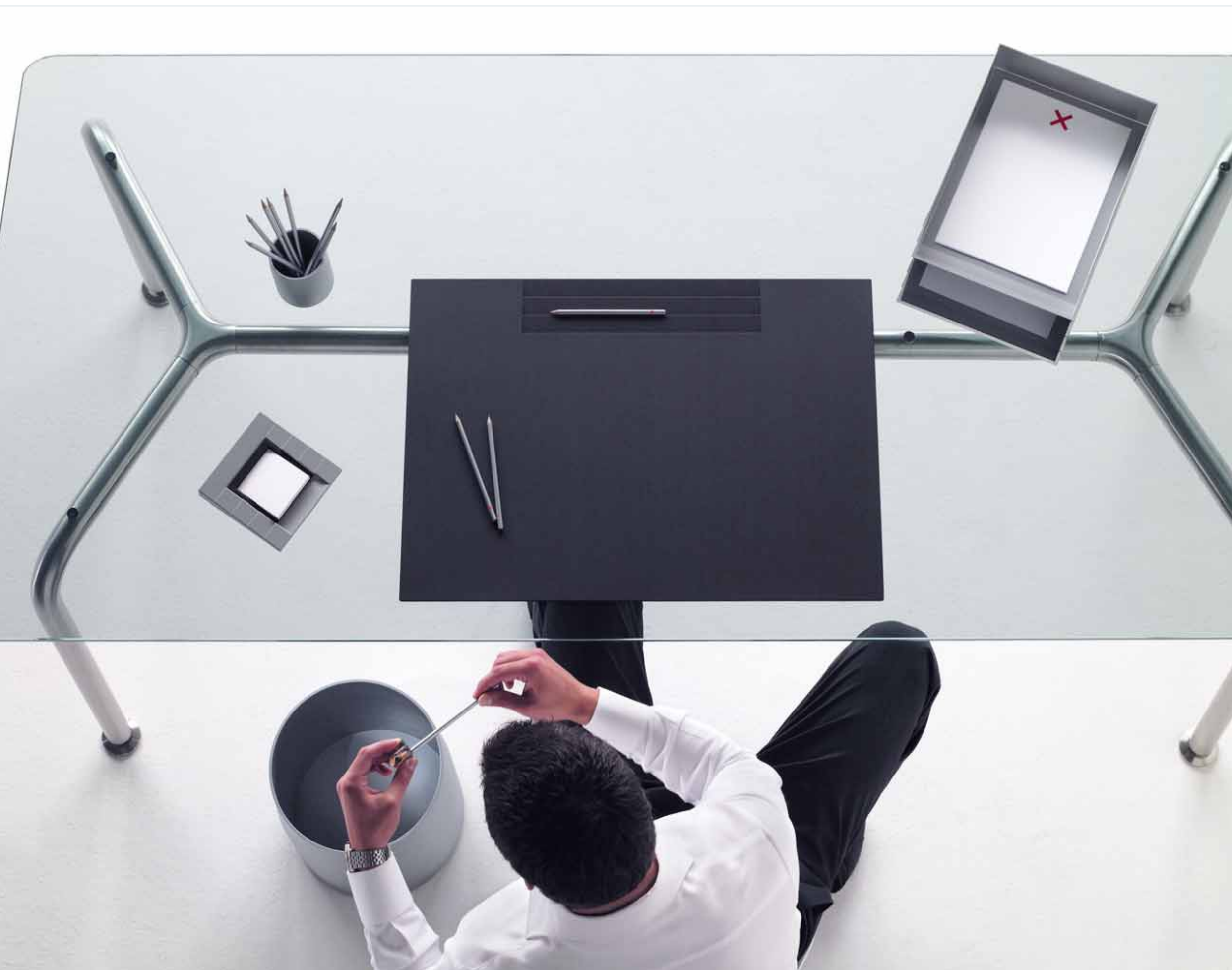

- 300. STATUS**
sottomano
desk pad
- 332. STATUS**
barattolo portamatite
pencil cup
- 340. STATUS**
portamemo
memo pad holder
- 350. STATUS**
vaschetta portacorrispondenza
letter tray
- 1400. STATUS**
cestino gettacarte
waste basket



303. STATUS
sottomano con segnaposto
per tavoli conferenze
conference desk pad with name holder

2140. CONVITO
tavolo quadrato
square table

2500. OLIVIA
sedia impilabile
stackable chair

BABELE

design Raul Barbieri
e Giorgio Marianelli 1980

940. **BABELE**
vaschetta portacorrispondenza
letter tray



Il set da scrivania Babele prende il nome dalla storica vaschetta portacorrispondenza disegnata nel 1980, ed è coordinato alla altrettanto storica collezione da terra Cribbio, del 1981. Una collezione dal design leggero ed elegante sempre attuale e ben riconoscibile, in polimero tecnico con finitura alluminio o nero. E' completata dal sottomano Modus in gomma naturale nera che incorpora una piccola vaschetta portamatite.

The Babele desktop series is named after historic letter tray designed in 1980. It fits the 1981 Cribbio standing item collection, also a historic one. A light and elegant design collection, always up-to-date and easily recognizable, in engineering polymer aluminium finish or black. It includes the Modus desk pad, in black natural rubber, with a small pencil tray.

L'ensemble de bureau Babele qui tient son nom du l'historique corbeille à courrier dessinée en 1980, est assorti à la tout autant historique collection sur pied Cribbio, de 1981. Une collection au design léger et élégant toujours actuel et facilement reconnaissable, en polymère technique avec finitions aluminium ou noir. Elle est complétée par le sous-main Modus en caoutchouc naturel noir qui incorpore une petite encoche porte-crayons.

Der Schreibtisch-Set Babele wird nach der 1980 gezeichneten historischen Briefablage benannt und wird der ebenso historischen Bodenkollektion Cribbio von 1981 beigeordnet. Eine Kollektion von leichtem und elegantem, immer aktuellem und gut erkennbarem Design. Alle Artikel sind aus Technischem-Polymer, alufarbig und schwarz. Die Kollektion wird vervollständigt durch die Schreibunterlage Modus mit einem kleinen Stiftablage, aus schwarzem Kautschuk.

El set de escritorio Babele toma el nombre de la histórica bandeja porta correspondencia diseñada en 1980, y combina con la también histórica colección de pie Cribbio, de 1981. Una colección con un diseño ligero y elegante siempre actual y reconocible, en polímero técnico acabado aluminio o negro. Se completa con el vade sobremesa Modus de goma natural negra que incluye una pequeña bandeja porta lápices.

- 940. BABELE**
vaschetta portacorrispondenza
letter tray
- 921. PODIO**
porta carte
letter rack
- 924. SLIM**
vaschetta portamatite
pencil tray
- 930. CENTOBUCHI**
barattolo portamatite
pencil cup
- 944. MEMO**
portamemo
memo pad holder
- 904. PLANO**
sottomano
desk pad
- 900. MULTIPLOR**
contenitore con cassette rotanti
rotating desk organizer

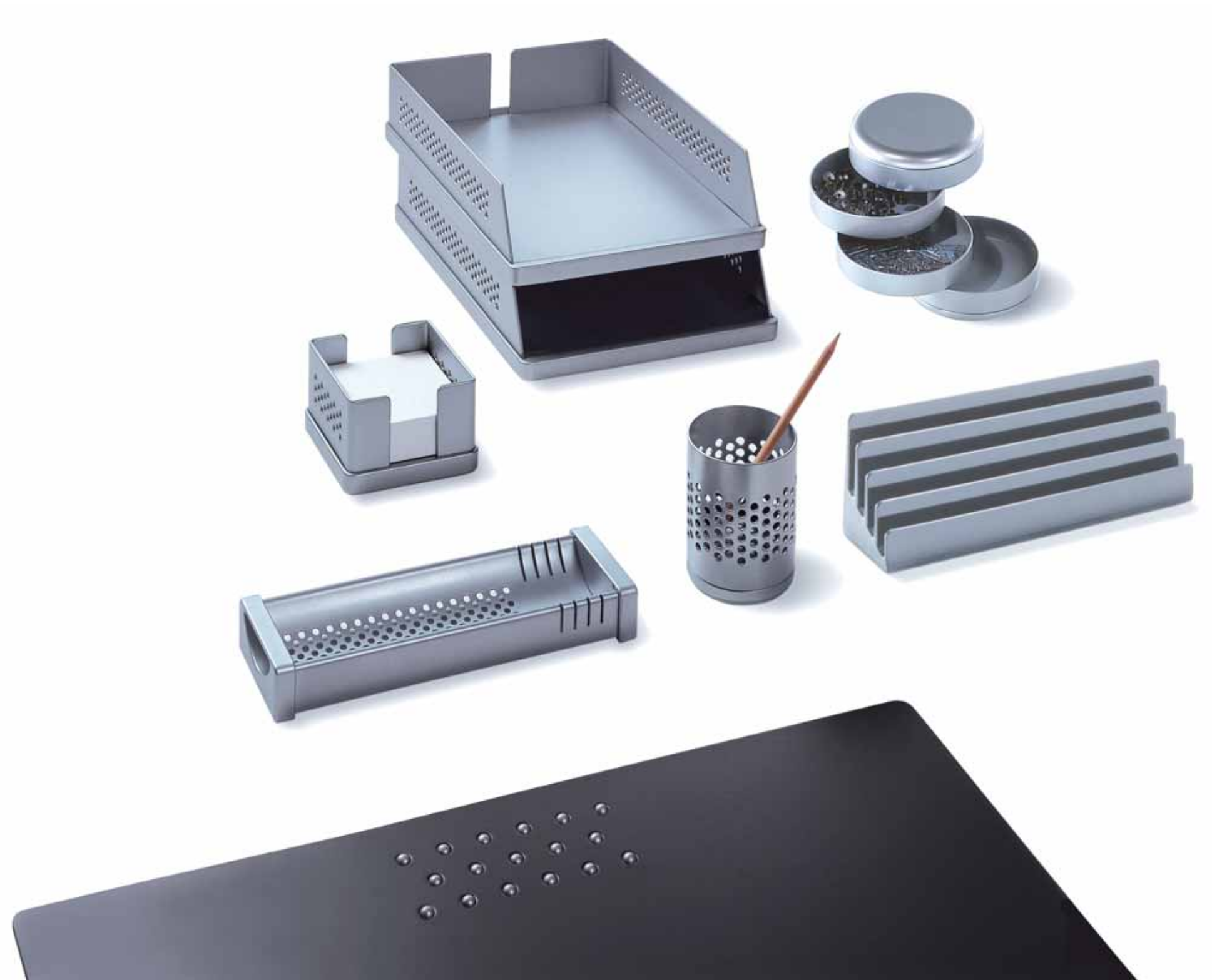



940. BABELE
vaschetta portacorrispondenza
letter tray

400. MODUS
sottomano con vaschetta portamatite
desk pad with pencil tray

930. CENTOBUCHI
barattolo portamatite
pencil cup

944. MEMO
portamemo
memo pad holder

1000. CRIBBIO
cestino gettacarte
waste basket



STANDARD
design Julian Brown 2004



632. STANDARD
barattolo portamatite
pencil cup

655. STANDARD
portacorrispondenza laterale
side letter tray

Un versatile set da scrivania e da parete dalla linea essenziale. Le vaschette portacorrispondenza, disponibili con apertura frontale o laterale, si affiancano al bicchiere portamatite, alla vaschetta portaoggetti e al portamemo, in polimero tecnico nelle varianti nero, alluminio e trasparente frost. L'ecologico sottomano Plano in linoleum nero completa il set.

Versatile desktop or wall set, featuring minimalist design. It comes with front or side opening letter trays, pencil cup, tray, and memo pad holder, in black, aluminium and frosted engineering polymer. The series also includes the eco-friendly Plano desk pad in black linoleum.

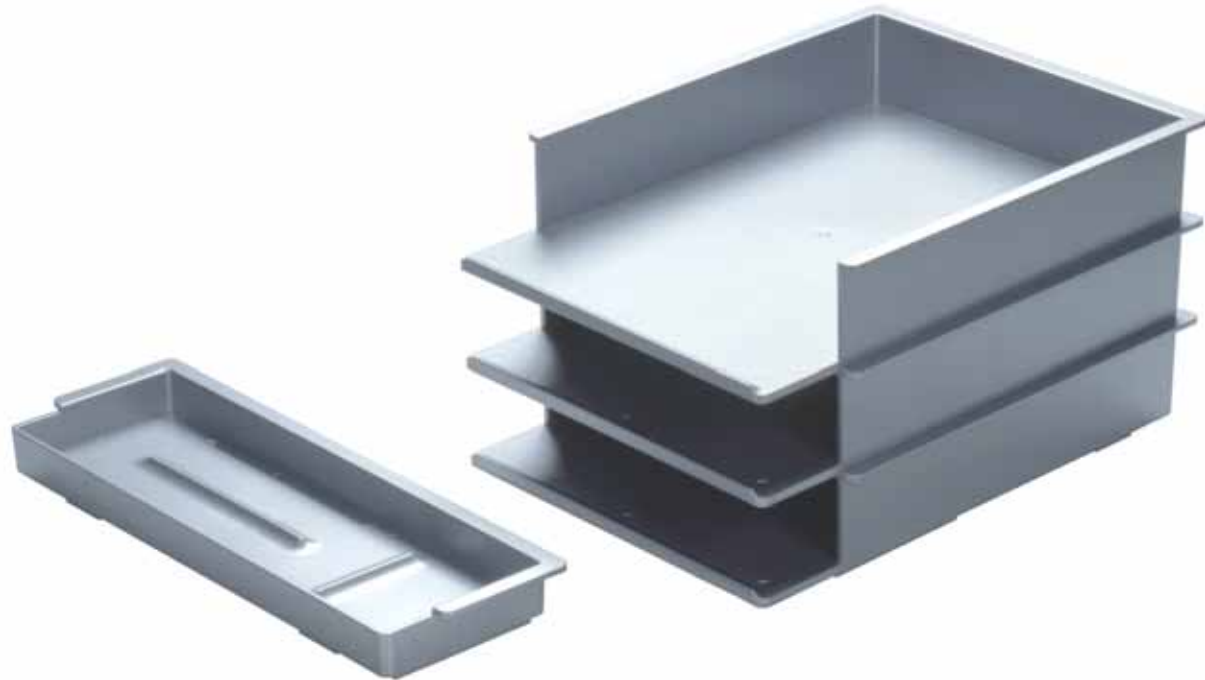

610. STANDARD

vaschetta portamatite
pencil tray

650. STANDARD

portacorrispondenza frontale
front letter tray

655. STANDARD

portacorrispondenza laterale
side letter tray

632. STANDARD

barattolo portamatite
pencil cup

640. STANDARD

portamemo/CD
memo pad/CD holder

Un ensemble de bureau et mural polyvalent reconnaissable à sa ligne essentielle. Les corbeilles à courrier, disponibles avec ouvertures frontales ou latérales, intègrent le pot à crayons, le plumier et le porte-mémo en polymère technique selon les variantes noir, aluminium ou transparent frost. L'ensemble est complété par le sous-main écologique Plano en linoléum noir.

Ein Set für Schreibtisch und Wand mit einer wesentlichen Linie. Die Frontal- oder Seitliche-Briefablage, lehnen sich dem Stiftköcher, dem Stiftablage und dem Zettelbox an und sind alle in Technischem-Polymer, schwarz, alufarbig oder transparent-frost erhältlich. Die umweltfreundliche Schreibunterlage Plano aus schwarzem Linoleum, vervollständigt das Schreibtisch-Set.

Un set de escritorio y de pared versátil con líneas esenciales. Las bandejas porta correspondencia, disponibles con apertura frontal o lateral, se unen al cubilete porta lápices, a la bandeja portaobjetos y al porta-notas en polímero técnico con variantes negro, aluminio y transparente frost. El vade sobremesa Plano, en ecológico linóleum negro completa el set.

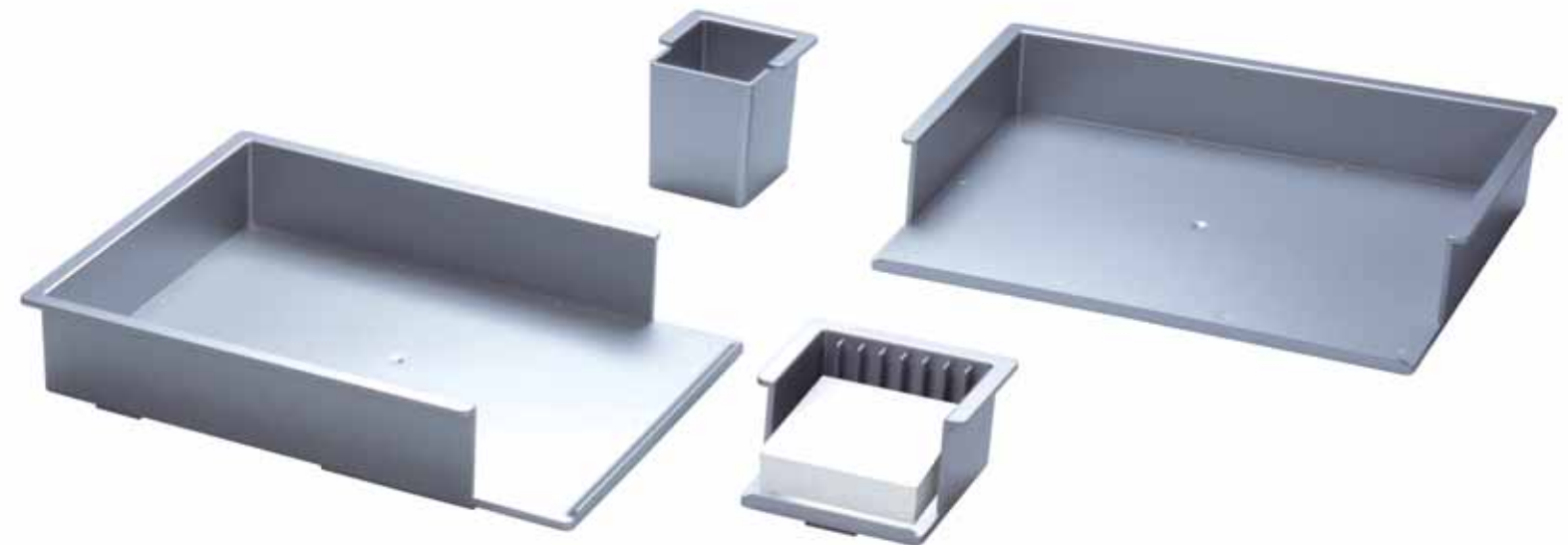



- 650. STANDARD**
portacorrispondenza frontale
front letter tray
- 610. STANDARD**
vaschetta portamatite
pencil tray
- 640. STANDARD**
portamemo/CD
memo pad/CD holder

Tutti i componenti della collezione Standard possono essere posizionati anche a parete, su appositi profili in alluminio anodizzato a uno oppure a tre livelli, in 3 diverse lunghezze: 80 cm, 100 cm, 120 cm.

The components of the Standard collection may also be fixed to a wall, to proper sections in anodized aluminium at one or three levels, in 3 different lengths: 80 cm, 100 cm, 120 cm (31¹/₂ - 39¹/₂ - 47¹/₄").

Tous les composants de la collection Standard peuvent être aussi positionnés sur le mur, sur des profils appropriés en aluminium anodisé à un ou trois niveaux, sur 3 différentes longueurs: 80 cm, 100 cm, 120 cm.

Alle Bestandteile der Standard-Kollektion können auch an die Wand positioniert werden, auf dafür bestimmten Eloxaluminium-Profilen einzeln oder auf drei Höhen, in 3 verschiedenen Längen von 80 cm, 100 cm, 120 cm.

Todos los componentes de la colección Standard también pueden ser colocados en la pared, sobre perfiles en aluminio anodizado adecuados a uno o tres niveles, en 3 tamaños diferentes: 80 cm, 100 cm, 120 cm.

610. STANDARD
vaschetta portamatite
pencil tray

632. STANDARD
barattolo portamatite
pencil cup

640. STANDARD
portamemo/CD
memo pad/CD holder

650. STANDARD
portacorrispondenza frontale
front letter tray

655. STANDARD
portacorrispondenza laterale
side letter tray

C080.
binario parete a 3 livelli
3 levels wall



ACCESSORI DA SCRIVANIA
DESK ACCESSORIES



500. HANNIBAL
design Julian Brown 1998
DISPENSER DI NASTRO ADESIVO
TAPE DISPENSER



900. MULTIPLOR
design Rino Pirovano 1977
CONTENITORE CON CASSETTI
ROTANTI
ROTATING DESK ORGANIZER



916. DUPLO 1980
919. GEMINI 1977
design Raul Barbieri e Giorgio Marianelli
REGGILIBRI
BOOKENDS



701. SAFE TRAY
design Raul Barbieri e Giorgio Marianelli 1977
POSACENERE DA TAVOLO
TABLE ASHTRAY



1690.NOX
design Raul Barbieri 2003
POSACENERE TAVOLI CONFERENZE
CONFERENCE TABLE ASHTRAY





MILAN

LONDRES

NUEVA YORK

MOSCOVA

BRUSELAS

BERLIN

BUDA PEST

CHICAGO

ATENAS

STUTTIGART

FILADELFIA

PRAGA

SANTIAGO

TOKIO

ROXAN

HABANA

MUNICH

am.

OROLOGI DA PARETE WALL CLOCK

Oltre a scandire il tempo che passa svolgono una piacevole funzione decorativa, a seconda delle rispettive personalità: dalle più rigorose in acciaio inossidabile o alluminio, alle più allegre, caratterizzate da dettagli multicolore.

Besides ticking the time, they are nice decorative objects, according to their own "personality": from the most rigorous ones, in stainless steel or aluminium, to the brightest ones with multicolour details.

En plus d'indiquer le temps qui passe, elles jouent aussi un plaisant rôle décoratif, selon leurs personnalités: des plus rigoureuses en acier inoxydable ou aluminium, aux plus joyeuses, caractérisées par des détails multi-couleurs.

Außer, dass sie die Zeit angeben, haben sie auch eine angenehme Dekorationsfunktion, je nach der entsprechenden Personalität: von den rigorosen aus Edelstahl oder Alufarbig bis zu den heiteren, die durch vielfarbigen Details charakterisiert werden.

Además de marcar el tiempo que pasa, desempeñan una agradable función decorativa, según las diferentes personalidades: desde las más rigurosas en acero inoxidable o aluminio, a las más alegres, caracterizadas por los detalles multicolores.

986. ORARIO
orologio da parete
wall clock



988. APPUNTAMENTO
design Raul Barbieri 1995

OROLOGIO A PENDOLO DA PARETE
PENDULUM WALL CLOCK

Ø 45 x 5,5 cm.
Ø 1 7/8" x 2 1/4"



986. ORARIO
design Raul Barbieri 1998

OROLOGIO DA PARETE
WALL CLOCK

Ø 45 x 5,5 cm.
Ø 1 7/8" x 2 1/4"



987. CONTRATTEMPO
design Raul Barbieri
e Giorgio Marianelli 1987

OROLOGIO A PENDOLO DA PARETE
PENDULUM WALL CLOCK

Ø 45 x 5,5 cm.
Ø 1 7/8" x 2 1/4"



980. ZERO
design Raul Barbieri
e Giorgio Marianelli 1981

OROLOGIO DA PARETE
WALL CLOCK

Ø 32 x 5 cm
Ø 1 2/8" x 2"



OLIVIA

design Raul Barbieri



SISTEMA DI SEDUTE
Seduta in polipropilene, struttura in acciaio cromato o inossidabile

SEATING SYSTEM
Polypropylene seat, chromium plated steel or stainless steel frame

2500. OLIVIA
SEDIA IMPILABILE

STACKABLE CHAIR

55 x 53 x h 76,5 cm
seduta h 46 cm
21 1/2 x 21 x h 30 1/4"
seat h 18"

**2501. OLIVIA**
POLTRONCINA IMPILABILE

STACKABLE ARMCHAIR

63 x 53 x h 76,5 cm
seduta h 46 cm
24 3/4 x 21 x h 30 1/4"
seat h 18"

**2502. OLIVIA**
SEDIA SU RUOTE

CHAIR ON CASTORS

Ø 54 x h 76,5 cm
seduta h 46 cm
Ø 21 1/4 x h 30 1/4"
seat h 18"

**2503. OLIVIA**
SEDIA SU RUOTE CON
ELEVAZIONE A GASCHAIR ON CASTORS
WITH GAS LIFT

Ø 54 x h 76,5 / 90 cm
seduta h 46 / 59,5 cm
Ø 21 1/4 x h 30 1/4 / 35 1/2"
seat h 18 / 23 1/2"

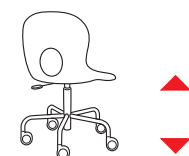
**2504. OLIVIA**
POLTRONCINA SU RUOTE

ARMCHAIR ON CASTORS

Ø 63 x h 76,5 cm
seduta h 46 cm
Ø 24 3/4 x h 30 1/4"
seat h 18"

**2505. OLIVIA**
POLTRONCINA SU RUOTE
CON ELEVAZIONE A GASARMCHAIR ON CASTORS
WITH GAS LIFT

Ø 63 x h 76,5 / 90 cm
seduta h 46 / 59,5 cm
Ø 24 3/4 x h 30 1/4 / 35 1/2"
seat h 18 / 23 1/2"

**2509. OLIVIA**
SEDIA CON TAVOLETTA SCRITTOIO
DESTRA

CHAIR WITH RIGHT WRITING TABLET

63 x 53 x h 76,5 cm
seduta h 46 cm
24 3/4 x 21 x h 30 1/4"
seat h 18"

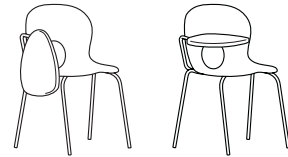
**2507. OLIVIA**
SEDIA CON TAVOLETTA SCRITTOIO
SINISTRA

CHAIR WITH LEFT WRITING TABLET

63 x 53 x h 76,5 cm
seduta h 46 cm
24 3/4 x 21 x h 30 1/4"
seat h 18"

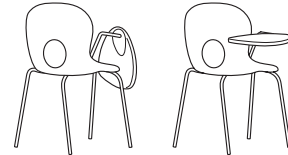
**2506. OLIVIA**
SGABELLO MEDIO IMPILABILE

STACKABLE KITCHEN STOOL

55 x 52 x h 96 cm
seduta h 67 cm
21 3/4 x 20 1/2 x h 37 3/4"
seat h 26 1/2"

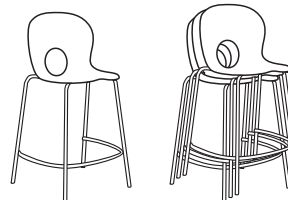
**2508. OLIVIA**
SGABELLO ALTO IMPILABILE

STACKABLE BAR STOOL

56,5 x 54 x h 108 cm
seduta h 79 cm
22 1/4 x 21 1/4 x h 42 1/2"
seat h 31"

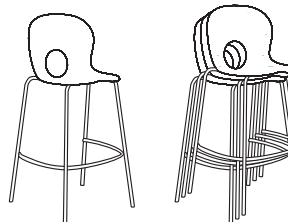
**115.**
CARRELLO
PER OLIVIA, ALEXA, EVELINETROLLEY
FOR OLIVIA, ALEXA, EVELINE

49 x 80 x h 126
19 1/4 x 31 1/2 x h 49 1/2"

**116.**
CARRELLO "PICK UP"
PER OLIVIA, ALEXA, EVELINE"PICK UP" TROLLEY
FOR OLIVIA, ALEXA, EVELINE

45 x 65 x h 110
17 3/4 x 25 1/2 x h 43 1/4"

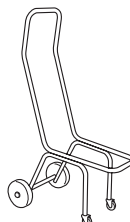
**OLIVIA**

design Raul Barbieri

SISTEMA DI SEDUTE SU BARRA
Seduta in polipropilene, piani in stratificato HPL 12 mm, barre in acciaio verniciato alluminio, gambe e braccioli in acciaio cromato

GANGING RAIL SEATING SYSTEM
Polypropylene seats, high pressure melamine laminate tops HPL 12 mm, rails in aluminium painted steel, legs and arms in chromium plated steel.

2510. OLIVIA
SEDUTA

46 x 42 x h 41 cm
18 x 16 1/2 x h 16 1/4"

**2513. OLIVIA**
BRACCIOLO

25,5 x h 26,5 cm
10 x h 10 1/2"

**2511. OLIVIA**
TAVOLINO

45 x 45 cm
17 3/4 x 17 3/4"

**2512. OLIVIA**
BARRA CON GAMBE

GANGING RAIL WITH LEGS

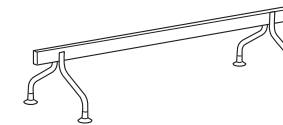
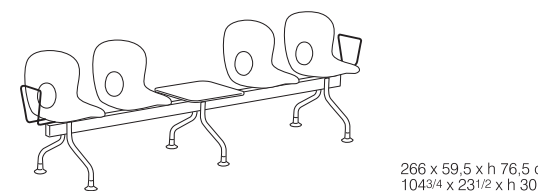
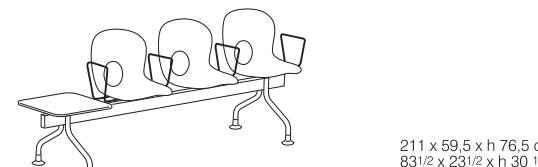
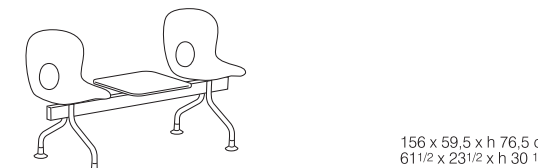
**ESEMPI DI COMPOSIZIONE**
EXAMPLES OF COMPOSITION**ALEXA**

design Raul Barbieri

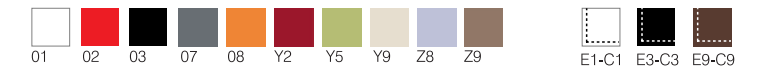

SEDE E POLTRONCINE
Struttura in alluminio pressofuso, seduta e schienale in polipropilene o rivestiti in cuoio o ecopelle.

CHAIRS AND ARMCHAIRS
Die-cast aluminium frame, seat and back in polypropylene or upholstered with leather or eco-leather.

2520. ALEXA
SEDIA IMPILABILE

STACKABLE CHAIR

50,5 x 54 x h 83 cm
seduta h 46 cm
19 3/4 x 21 1/4 x h 32 3/4"
seat h 18"

**2521. ALEXA**
POLTRONCINA IMPILABILE

STACKABLE ARMCHAIR

56,5 x 54 x h 83 cm
seduta h 46 cm
22 1/4 x 21 1/4 x h 32 3/4"
seat h 18"

**2529. ALEXA**
SEDIA CON TAVOLETTA SCRITTOIO
DESTRA

CHAIR WITH RIGHT WRITING TABLET

57 x 54 x h 83 cm
seduta h 46 cm
22 1/2 x 21 1/4 x h 32 3/4"
seat h 18" cm

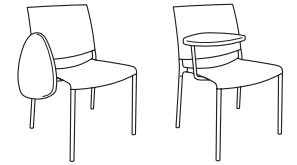
**2530. ALEXA**
SEDIA CON TAVOLETTA SCRITTOIO
SINISTRA

CHAIR WITH LEFT WRITING TABLET

57 x 54 x h 83 cm
seduta h 46 cm
22 1/2 x 21 1/4 x h 32 3/4"
seat h 18" cm

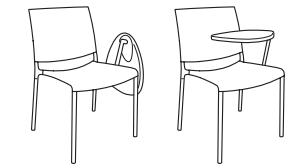
**EVELINE**

design Raul Barbieri



SEDA
Stampata in policarbonato in un unico pezzo, in colori solidi o trasparenti oppure verniciata "silver", "gold" o nero "soft touch"

CHAIR
Moulded in polycarbonate in one piece, in solid or transparent colours or painted "silver", "gold" or black "soft touch"

2540. EVELINE
SEDIA IMPILABILE

STACKABLE CHAIR

48,5 x 53,5 x h 82,5 cm
seduta h 47 cm
19 x 21 x h 32 1/2"
seat h 18 1/2" cm



ZANZIBAR
design Raul Barbieri

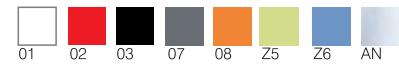

SGABELLI
Seduta e cono in polimero tecnico, gamba, appoggiapiedi e base in acciaio cromato, guarnizione salva-pavimento in gomma.

STOOLS
Engineering polymer seat and cone, chromium plated steel leg, footrest and base, floor protection in rubber.

2210. ZANZIBAR
SGABELLO
CON ELEVAZIONE A GAS

STOOL WITH GAS LIFT
ADJUSTABLE HEIGHT

Ø 38 x h 50/75 cm
Ø 15 x h 19 1/2 / 29 1/2"

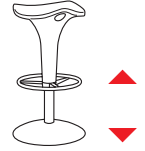

ZANZIBAR
design Raul Barbieri
SGABELLO AD ALTEZZA FISSA

STOOL WITH FIXED HEIGHT

2211. ZANZIBAR
Ø 38 x h 47,5 cm
Ø 15 x h 18 3/4"

2212. ZANZIBAR
Ø 38 x h 65 cm
Ø 15 x h 25 1/2"

2213. ZANZIBAR
Ø 38 x h 77 cm
Ø 15 x h 30 1/4"

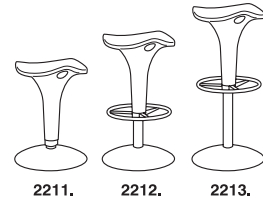

ZANZIBAR
design Raul Barbieri
SGABELLO CON ELEVAZIONE A GAS
E GIUNTO DI FISSAGGIO A PAVIMENTO

STOOL WITH GAS LIFT
AND FLOOR FIXING JOINT

2214. ZANZIBAR
Ø 38 x h 50/75 cm
Ø 15 x h 19 1/2 / 29 1/2"

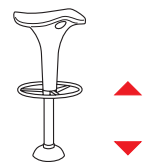

ZANZI SWING
design Raul Barbieri

SGABELLO BASCULANTE
CON ELEVAZIONE A GAS

SWINGING STOOL
WITH GAS LIFT

2220. ZANZI SWING
Ø 38 x h 49/64 cm
Ø 15 x h 19 1/4 / 25 1/4"

2221. ZANZI SWING
Ø 38 x h 53,5 / 80 cm
Ø 15 x h 21 / 31 1/2"

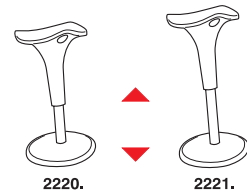

WELCOME
design Raul Barbieri

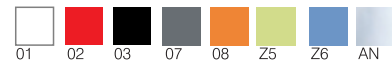

SGABELLO SU RUOTE CON ELEVAZIONE A GAS
Seduta in polimero tecnico, struttura in acciaio cromato.

STOOL ON CASTORS WITH GAS LIFT
Engineering polymer seat, chromium plated steel frame.

2265. WELCOME
Ø 54 x h 42 / 55,5 cm
Ø 21 1/4 x h 16 1/2 / 21 3/4"

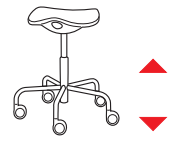

WELL
design Raul Barbieri



SGABELLI
Seduta in polimero tecnico, struttura in acciaio cromato.

STOOLS
Engineering polymer seat, chromium plated steel frame.

2260. WELL
SGABELLO IMPILABILE

STACKABLE STOOL

Ø 46 x h 45 cm
Ø 18 x h 17 3/4"



2261. WELL
SGABELLO MEDIO

KITCHEN STOOL

Ø 52 x h 65 cm
Ø 20 1/2 x h 25 1/2"



2262. WELL
SGABELLO ALTO

BAR STOOL

Ø 54 x h 77 cm
Ø 21 x h 30"



ZANZIPLANO
design Raul Barbieri



TAVOLI E TAVOLINI
Piano in stratificato melaminico antigraffio HPL 12 mm, struttura in acciaio cromato, cono in polimero tecnico. Guarnizione salva pavimento in gomma.

TABLES AND COFFEE TABLES
Scratch resistant high pressure melamine laminate top HPL 12 mm, chromium plated steel frame, engineering polymer cone. Floor protection in rubber.

2239. ZANZIPLANO
Ø 60 x h 75 cm
Ø 23 1/2 x h 29 1/2"

2240. ZANZIPLANO
Ø 60 x h 105 cm
Ø 23 1/2 x h 41 1/4"

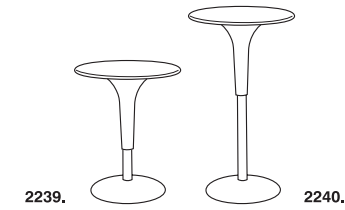

2241. ZANZIPLANO
60 x 60 x h 75 cm
23 1/2 x 23 1/2 x h 29 1/2"

2242. ZANZIPLANO
60 x 60 x h 105 cm
23 1/2 x 23 1/2 x h 41 1/4"



2245. ZANZIPLANO
80 x 80 x h 75 cm
31 1/2 x 31 1/2 x h 29 1/2"

2246. ZANZIPLANO
80 x 80 x h 105 cm
31 1/2 x 31 1/2 x h 41 1/4"



2250. ZANZIPLANO
Ø 90 x h 75 cm
Ø 35 1/2 x h 29 1/2"

2251. ZANZIPLANO
Ø 90 x h 105 cm
Ø 35 1/2 x h 41 1/4"

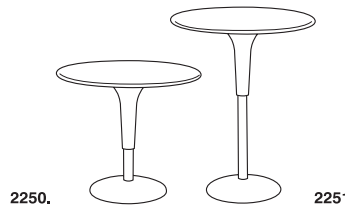

Z1

2255. ZANZIPLANO
Ø 110 x h 75 cm
Ø 43 1/4 x h 29 1/2"



ENRICO X
design Alberto Basaglia e Natalia Rota Nodari



TAVOLI
Struttura in alluminio anodizzato naturale o lucidato, con angoli in alluminio lucidato. Piano in laminato antigraffio 10 mm bianco oppure in cristallo temperato 10 mm trasparente, opaco o bianco.

TABLES
Base in natural anodized or polished aluminium with polished corners. Top in scratch resistant 10 mm laminate white or in 10 mm tempered crystal transparent, matt or white.

2070. ENRICO X
TAVOLO QUADRATO

SQUARE TABLE

135 x 135 x h 73,5 cm
53 x 53 x h 29"



2072. ENRICO X
TAVOLO RETTANGOLARE

RECTANGULAR TABLE

120 x 85 x h 73,5 cm
47 1/4 x 33 1/2 x h 29"



2074. ENRICO X
TAVOLO RETTANGOLARE

RECTANGULAR TABLE

160 x 85 x h 73,5 cm
63 x 33 1/2 x h 29"



2076. ENRICO X
TAVOLO RETTANGOLARE

RECTANGULAR TABLE

190 x 95 x h 73,5 cm
75 x 37 1/2 x h 29"



CONVITO
design Raul Barbieri



TAVOLI
Struttura in acciaio verniciato bianco antigraffio o in acciaio inossidabile AISI 304 satinato. Piano in cristallo temperato 12 mm trasparente, opaco o bianco.

TABLES
Base in steel scratch resistant painted in white or in brushed stainless steel AISI 304. Tempered 12 mm crystal top transparent, matt or white.

2135. CONVITO
TAVOLO ROTONDO
ROUND TABLE

Ø 135 x h 75 cm
Ø 53 x h 29 1/2"

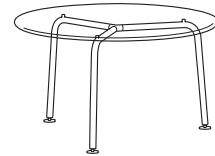

2140. CONVITO
TAVOLO QUADRATO
SQUARE TABLE

140 x 140 x h 75 cm
55 x 55 x h 29 1/2"

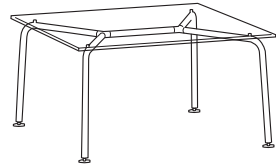

2142. CONVITO
TAVOLO RETTANGOLARE
RECTANGULAR TABLE

160 x 80 x h 75 cm
63 x 31 1/2 x h 29 1/2"

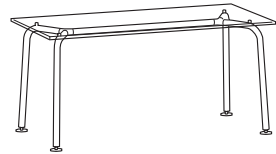

2144. CONVITO
TAVOLO RETTANGOLARE
RECTANGULAR TABLE

200 x 95 x h 75 cm
78 3/4 x 37 1/2 x h 29 1/2"



2148. CONVITO
TAVOLO RETTANGOLARE
RECTANGULAR TABLE

225 x 140 x h 75 cm
88 1/2 x 55 x h 29 1/2"

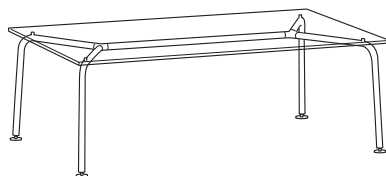

ALEX
design Raul Barbieri



TAVOLI
Struttura in fusione di alluminio lucidata, cromata oppure verniciata antigraffio in bianco o nero. Piano in cristallo temperato 12 mm trasparente, opaco o bianco.

TABLES
Base in aluminium casting, polished, chromium plated or scratch-resistant painted in white or black. Tempered 12 mm crystal top transparent, matt or white.

2150. ALEX
TAVOLO QUADRATO
SQUARE TABLE

160 x 160 x h 75 cm
63 x 63 x h 29 1/2"

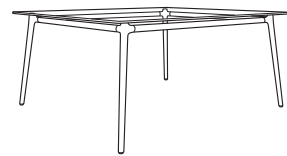

2152. ALEX
TAVOLO RETTANGOLARE
RECTANGULAR TABLE

140 x 90 x h 75 cm
55 x 35 1/2 x h 29 1/2"

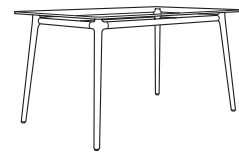

2154. ALEX
TAVOLO RETTANGOLARE
RECTANGULAR TABLE

170 x 90 x h 75 cm
67 x 35 1/2 x h 29 1/2"



2156. ALEX
TAVOLO RETTANGOLARE
RECTANGULAR TABLE

200 x 100 x h 75 cm
78 3/4 x 39 1/2 x h 29 1/2"



2158. ALEX
TAVOLO RETTANGOLARE
RECTANGULAR TABLE

230 x 100 x h 75 cm
90 1/2 x 39 1/2 x h 29 1/2"

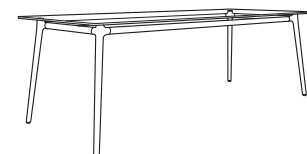

POPPY
design Raul Barbieri



TAVOLINI
Base in acciaio ricoperto in polimero tecnico bianco, rosso o nero; gamba in acciaio verniciato negli stessi colori. Piano in cristallo temperato 8 mm bianco, rosso o nero. Guarnizione salva-pavimento in gomma.

SIDE TABLES
Steel base with white, red or black engineering polymer cover; steel leg painted in the same colours. Tempered 8 mm crystal top white, red or black. Floor protection in rubber.

2101. POPPY
Ø 38 x h 40 cm
Ø 15 x h 15 3/4"



2101.

2102. POPPY
Ø 38 x h 56 cm
Ø 15 x h 22"

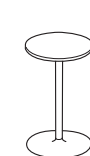

2102.

2103. POPPY
Ø 38 x h 72 cm
Ø 15 x h 28 1/4"

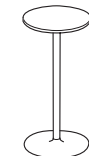

2103.

2105. POPPY
Ø 50 x h 40 cm
Ø 19 3/4 x h 15 3/4"



2105.

2106. POPPY
Ø 50 x h 56 cm
Ø 19 3/4 x h 22"



2106.

2107. POPPY
Ø 50 x h 72 cm
Ø 19 3/4 x h 28 1/4"

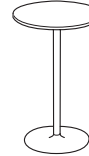

2107.

DESCO
design Raul Barbieri



TAVOLINI
Struttura in acciaio verniciato antigraffio bianco o nero, oppure in acciaio inossidabile AISI 304 satinato. Piano in cristallo temperato 8 mm trasparente, opaco, fumè, bianco o nero.

COFFEE TABLES
Frame in steel scratch resistant painted white or black, or in brushed stainless steel AISI 304. Tempered crystal top 8 mm transparent, matt, smoky, white or black.

2129. DESCO
Ø 60 x h 45 cm
Ø 23 1/2 x h 17 3/4"

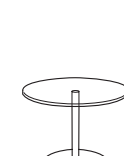

2129.

2131. DESCO
Ø 60 x h 75 cm
Ø 23 1/2 x h 29 1/2"

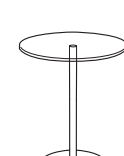

2131.

2132. DESCO
Ø 60 x h 105 cm
Ø 23 1/2 x h 41 1/4"

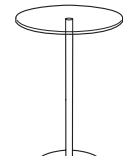

2132.

BANCO LIGHT
design Raul Barbieri

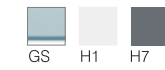

SCRITTOIO PER COMPUTER
Struttura in alluminio anodizzato naturale. Piani: cristallo temperato 8 mm opaco oppure in stratificato melaminico HPL 8 mm bianco ghiaccio o grigio.

COMPUTER DESK
Frame in natural anodized aluminium. Shelves in 8 mm matt tempered crystal, or in high pressure melamine laminate 8 mm HPL off-white or grey.

2021. BANCO LIGHT
88 x 63 x h 73 cm
34 3/4 x 25 x h 28 3/4"

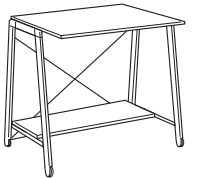

201. SUPPORTO ESTRAIBILE PER TASTIERA

PULL-OUT KEYBOARD TRAY

77,5 x 31,5 x h 3 cm
30 1/2 x 12 1/2 x h 1 1/4"



TENDER
design Raul Barbieri



CARRELLO E VASSOIO
Struttura in acciaio cromato, vassoi in polimero tecnico.

TROLLEY AND TRAY
Chromium-plated steel frame, engineering polymer trays.

2299. TENDER
62 x 46 x h 72 cm
24 1/2 x 18 x h 28 1/4"

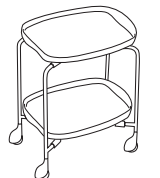

2301. TENDER
62 x 46 x h 5 cm
24 1/2 x 18 x h 2"



NEWS
design Raul Barbieri

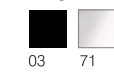

PORTARIMSTE PIEGHEVOLE
Struttura in alluminio, supporti in polipropilene nero o traslucido.

FOLDING MAGAZINE RACK
Aluminium frame, black or translucent polypropylene holders.

2400. NEWS
58 x 46,5 x h 50,5 cm
23 x 18 1/4 x h 20"



BOOX

design Alberto Basaglia e Natalia Rota Nodari

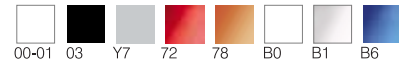

SISTEMA CONTENITORE MODULARE

Struttura in alluminio estruso lucidato o anodizzato naturale, piani in vetro temperato trasparente, opaco, bianco, nero o finitura alluminio. Pannelli e antine in metacrilato colorato, piedini regolabili. Il sistema può essere attrezzato con pannelli posteriori, laterali, antine scorrevoli o basculanti e con cassetti.

MODULAR SHELVING SYSTEM

Frame in polished or natural anodized extruded aluminium, shelves in tempered glass transparent, matt, white, black or aluminium finish. Panels and doors in coloured methacrylate, adjustable feet. The system can be equipped with back and side panels, sliding or swinging doors and with drawers.

2700 BOOX

Profondità 45 cm
Dimensioni moduli:
larghezza 60 e 90 cm
altezza utile 34,5 e 40 cm

Depth 17 3/4"
Modules dimensions:
width 23 1/2" and 35 1/2"
useful height 13 1/2" and 15 3/4"

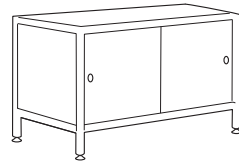

2701 BOOX

Profondità 35 cm
Dimensioni moduli:
larghezza 60 e 90 cm
altezza utile 34,5 e 40 cm

Depth 13 3/4"
Modules dimensions:
width 23 1/2" and 35 1/2"
useful height 13 1/2" and 15 3/4"

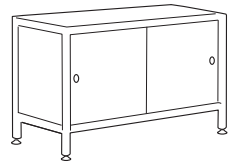

2702 BOOX DOPPIO

Profondità 62 cm
Dimensioni moduli:
larghezza 60 e 90 cm
altezza utile 34,5 e 40 cm

Depth 32 1/4"
Modules dimensions:
width 23 1/2" and 35 1/2"
useful height 13 1/2" and 15 3/4"

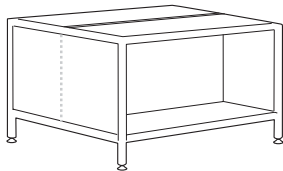

2700. BOOX CORNER

Profondità 45 cm
Dimensioni moduli:
larghezza 60 e 90 cm
altezza utile 34,5 e 40 cm

Depth 17 3/4"
Modules dimensions:
width 23 1/2" and 35 1/2"
useful height 13 1/2" and 15 3/4"

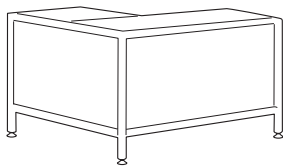

2701. BOOX CORNER

Profondità 35 cm
Dimensioni moduli:
larghezza 60 e 90 cm
altezza utile 34,5 e 40 cm

Depth 13 3/4"
Modules dimensions:
width 23 1/2" and 35 1/2"
useful height 13 1/2" and 15 3/4"

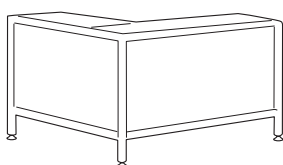

BOOX ACCESSORI

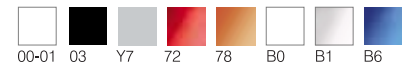

ACCESSORI

Pannelli e antine in metacrilato colorato.

ACCESSORIES

Panels and doors in coloured methacrylate.

2700.

COPPIA ANTINE SCORREVOLI
COUPLE OF SLIDING DOORS

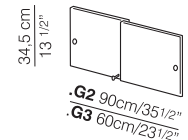
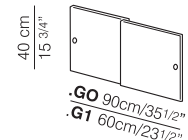

171.

COPPIA ANTINE CON CHIAVE
COUPLE OF DOORS WITH KEY

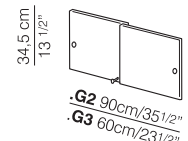
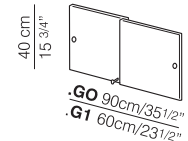

182.

COPPIA CASSETTI
COUPLE OF DRAWERS

.9A senza chiave / without key
.9B con chiave / with key

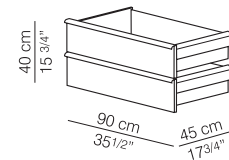

178.

ANTA BASCULANTE
SWINGING DOOR

.9A senza chiave / without key
.9B con chiave / with key

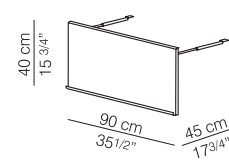

186.

CASSETTO PER CARTELLE SOSPESSE
DRAWER FOR HANGING FOLDERS

.9A senza chiave / without key
.9B con chiave / with key

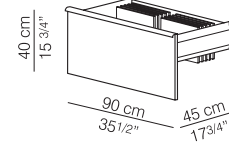

ESEMPI DI COMPOSIZIONE
EXAMPLES OF COMPOSITION

BOOX



BOOX DOPPIO



BOOX CORNER



CACTUS
design Raul Barbieri

APPENDIABITI DA TERRA
CON PORTAOMBRELLI
Acciaio e polimeri tecnici.

COAT STAND WITH
UMBRELLA STAND
Steel and engineering
polymers.

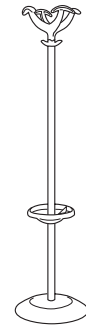

1070. CACTUS
Ø 40 x h 167 cm
Ø 15 3/4 x h 65 3/4"

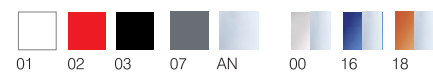
POP
design Raul Barbieri

APPENDIABITI DA TERRA
Acciaio e polimeri tecnici,
guarnizione salvapavimento
in gomma.

COAT STAND
Steel and engineering polymers,
floor protection in rubber.

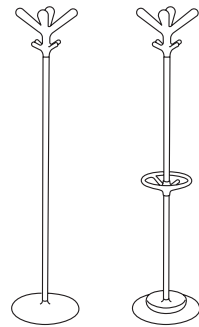

1080. POP
Ø 38 x h 167 cm
Ø 15 x h 65 3/4"

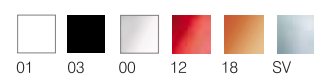
GRU
design Raul Barbieri

GRUCCIA
Polimeri tecnici.

HANGER
Engineering polymers.



998. GRU
43 x 3,5 x h 18,5 cm
17 x 1 x h 7 1/4"

DOPPIOPETTO
design Raul Barbieri

APPENDIABITI DA TERRA
Acciaio e polimeri tecnici,
guarnizione salvapavimento
in gomma.

COAT STAND
Steel and engineering polymers,
floor protection in rubber.

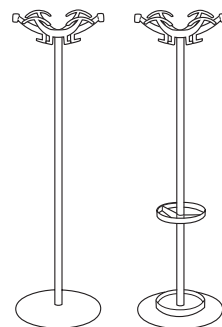

1090. DOPPIOPETTO
Ø 52 x h 167 cm
Ø 20 1/2 x h 65 3/4"

AIUTO
design Barbieri e Marianelli

APPENDIABITI DA TERRA
Acciaio, polimeri tecnici,
guarnizione salva-pavimento
in gomma.

COAT STAND
Steel, engineering polymers,
floor protection in rubber.

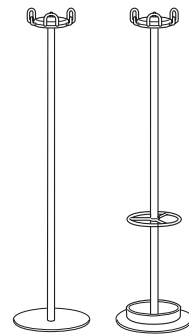

999. AIUTO
Ø 36 x h 165 cm
Ø 14 1/4 x h 65"

UNPOSTO DUEPOSTI TREPOSTI
design Barbieri e Marianelli

APPENDIABITI SINGOLO DA PARETE
Polimero tecnico

SINGLE WALL COAT RACK
Engineering polymer



991. UNPOSTO
9,5 x 7,5 x h 10 cm
3 3/4 x 3 x h 4"

APPENDIABITI DOPPIO DA PARETE
Polimero tecnico

DOUBLE WALL COAT RACK
Engineering polymer



992. DUEPOSTI
30 x 7,5 x h 10 cm
11 3/4 x 3 x h 4"

APPENDIABITI TRIPLO DA PARETE
Polimero tecnico

TRIPLE WALL COAT RACK
Engineering polymer



992. TREPOSTI
45 x 7,5 x h 10 cm
17 3/4 x 3 x h 4"

CRIBBIO COLLECTION
design Barbieri e Marianelli

Contenitori in unico pezzo di acciaio senza saldature,
guarnizione salva-pavimento in gomma.

Containers in one single steel piece without
weldings, floor protection in rubber.

1000. CRIBBIO
CESTINO GETTACARTE

WASTE BASKET

Ø 26,5 x h 30,5 cm (15 litri)
Ø 10 1/2 x h 12" (4 gallons)



1010. CRIBBIO
PORTAOMBRELLI /
CESTINO ALTO

UMBRELLA STAND /
TALL WASTE BASKET

Ø 26,5 x h 45 cm (22 litri)
Ø 10 1/2 x h 17 3/4" (5 3/4 gallons)



15. VASCHETTA ECOLOGICA PER
1000 - 1010 - 1050 - 1051
1100 - 1102 - 1400 - 1440
Polimero tecnico

ECOLOGY CUP FOR
1000 - 1010 - 1050 - 1051
1100 - 1102 - 1400 - 1440
Engineering polymer

19 x 12,5 x h 15 cm (1,5 litri)
7 1/2 x 5 x h 6" (1/2 gallon)



1020. CRIBBIO
POSACENERE DA TERRA
CON GETTACARTE

FLOOR ASHTRAY
WITH WASTE BASKET

Ø 26,5 x h 65 cm
Ø 10 1/2 x h 25 1/2"

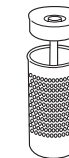

1030. CRIBBIO
APPENDIABITI DA TERRA CON
PORTAOMBRELLI
Acciaio, polimeri tecnici,
guarnizione salva-pavimento
in gomma.

COAT STAND
WITH UMBRELLA STAND
Steel, engineering polymers,
floor protection in rubber.

Ø 26,5 x h 168 cm
Ø 10 1/2 x h 66 1/4"

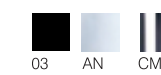
**COLMO COLLECTION**
design Barbieri e Marianelli

Contenitori in unico pezzo di acciaio senza
saldature, guarnizione salva-pavimento in gomma.

Containers in one single steel piece without
weldings, floor protection in rubber.

1050. COLMO
CESTINO GETTACARTE

WASTE BASKET

Ø 26,5 x h 30,5 cm (15 litri)
Ø 10 1/2 x h 12" (4 gallons)



1051. COLMO
PORTAOMBRELLI /
CESTINO ALTO

UMBRELLA STAND /
TALL WASTE BASKET

Ø 26,5 x h 45 cm (22 litri)
Ø 10 1/2 x h 17 3/4" (5 3/4 gallons)



15. VASCHETTA ECOLOGICA PER
1000 - 1010 - 1050 - 1051
1100 - 1102 - 1400 - 1440
Polimero tecnico

ECOLOGY CUP FOR
1000 - 1010 - 1050 - 1051
1100 - 1102 - 1400 - 1440
Engineering polymer

19 x 12,5 x h 15 cm (1,5 litri)
7 1/2 x 5 x h 6" (1/2 gallon)



1052. COLMO
POSACENERE DA TERRA
CON GETTACARTE

COMBINATION FLOOR ASHTRAY
AND WASTE BASKET

Ø 26,5 x h 65 cm
Ø 10 1/2 x h 25 1/2"

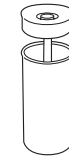

1053. COLMO
APPENDIABITI DA TERRA CON
PORTAOMBRELLI
Acciaio, polimeri tecnici,
guarnizione salva-pavimento
in gomma

COMBINATION COAT AND
UMBRELLA STAND
Steel, engineering polymers,
floor-protective rubber trim

Ø 26,5 x h 168 cm
Ø 10 1/2 x h 66 1/4"

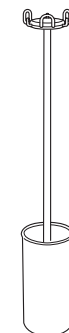

TABOO

design Raul Barbieri



Cestino gettacarte e vaschetta ecologica in polimero tecnico.

Waste basket and ecology cup in engineering polymer.

1460. TABOO
CESTINO GETTACARTE
WASTE BASKET

26 x 28 x h 35 cm
10 1/4 x 11 x h 13 3/4" cm

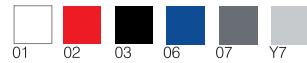

18. TABOO
VASCHETTA ECOLOGICA
ECOLOGY CUP

24x 14,5 x h 17 cm
9 1/2 x 5 3/4 x h 6 3/4" cm

**ECO**

design Raul Barbieri

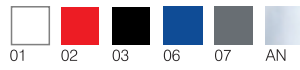

Cestino gettacarte, vaschetta ecologica e anello coprisacchetto in polimero tecnico.

Waste basket, ecology cup and bag cover ring in engineering polymer.

1500. ECO
CESTINO GETTACARTE
WASTE BASKET

28 x 28 x h 32 cm (13,5 litri)
11 x 11 x h 12 1/2" (3 1/2 gallons)



16. ECO
VASCHETTA ECOLOGICA
ECOLOGY CUP

25 x 16 x h 15 cm (2 litri)
9 3/4 x 6 1/4 x h 6" (1/2 gallon)



17. ECO
ANELLO COPRISACCHETTO
BAG COVER RING

29,5 x 29,5 x h 7 cm
11 1/2 x 11 1/2 x h 2 3/4"

**ECO PRO**

design Raul Barbieri

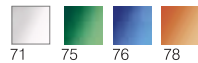

Cestino gettacarte, vaschetta ecologica e anello coprisacchetto in polipropilene.

Waste basket, ecology cup and bag cover ring in engineering polypropylene.

1500.PP. ECO PRO
CESTINO GETTACARTE
WASTE BASKET

28 x 28 x h 32 cm (13,5 litri)
11 x 11 x h 12 1/2" (3 1/2 gallons)



16.PP. ECO PRO
VASCHETTA ECOLOGICA
ECOLOGY CUP

25 x 16 x h 15 cm (2 litri)
9 3/4 x 6 1/4 x h 6" (1/2 gallon)



17.PP. ECO PRO
ANELLO COPRISACCHETTO
BAG COVER RING

29,5 x 29,5 x h 7 cm
11 1/2 x 11 1/2 x h 2 3/4"

**STATUS**

design Raul Barbieri



Cestino gettacarte e portaombrelli in polimero tecnico verniciato, guarnizione salvapavimento in gomma.

Waste basket and umbrella stand in painted engineering polymer, floor protection in rubber.

1400. STATUS
CESTINO GETTACARTE
WASTE BASKET

Ø 30 x h 32 cm (18 litri)
Ø 11 3/4 x h 12 1/2" (4 3/4 gallons)



1440. STATUS
PORTAOMBRELLI /
CESTINO ALTO

UMBRELLA STAND /
TALL WASTE BASKET

Ø 30 x h 52 cm (30 litri)
Ø 11 3/4 x h 20 1/2" (8 gallons)



20. STATUS
ANELLO COPRISACCHETTO

BAG COVER RING

Ø 30 x h 10 cm
Ø 11 3/4 x 4"



21. STATUS
ANELLO CON COPERCHIO
BASCULANTE

RING WITH FLIP TOP LID

Ø 30 x h 10 cm
Ø 11 3/4 x h 4"

**BIRILLO**

design Giotto Stoppino



Cestini gettacarte, portaombrelli, posacenere da terra in polimero tecnico.

Waste baskets, umbrella stand, floor ashtrays in engineering polymer.

1100. BIRILLO
CESTINO GETTACARTE
WASTE BASKET

Ø 25,5 x h 38 cm (18 litri)
Ø 10 x h 15" (4 3/4 gallons)



1200. BIRILLO
PORTAOMBRELLI / BASE
POSACENERE DA TERRA

UMBRELLA STAND /
FLOOR ASHTRAY BASE

Ø 25,5 x h 60 cm (18 litri)
Ø 10 x h 23 1/2" (4 3/4 gallons)

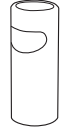
**BIRILLO PLUS**

design Giotto Stoppino

Corpo senza fondo in polimero tecnico, contenitore interno in banda stagnata.

Engineering polymer bottomless body, internal white latten can.

1102. BIRILLO PLUS
CESTINO GETTACARTE
WASTE BASKET

Ø 25,5 x h 38 cm
Ø 10 x h 15"

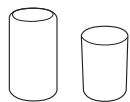

1202. BIRILLO PLUS
CESTINO ALTO / BASE
POSACENERE DA TERRA

TALL WASTE BASKET /
FLOOR ASHTRAY BASE

Ø 25,5 x h 60 cm
Ø 10 x h 23 1/2"

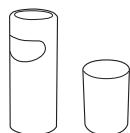

30. BIRILLO PLUS
VASCHETTA POSACENERE
PER BIRILLO 1200 - 1202
Acciaio

ASHTRAY CUP FOR
BIRILLO 1200 - 1202
Steel

Ø 22 x h 6 cm
Ø 8 1/2 x h 2 1/2"



50. BIRILLO PLUS
VASCHETTA POSACENERE CON
GRIGLIA PER BIRILLO 1200 - 1202
Acciaio

ASHTRAY CUP WITH GRID
FOR BIRILLO 1200 - 1202
Steel

Ø 22 x h 9 cm
Ø 8 1/2 x h 3 1/2"



NOX
 design Raul Barbieri

Cestini gettacarte, portaombrelli, posacenere da terra in acciaio inossidabile AISI 304 0,8 mm satinato con saldatura invisibile, bordi arrotondati antinfortunio, guarnizione salva-pavimento in gomma.

Waste basket, umbrella stand, floor ashtrays in brushed stainless steel AISI 304 0,8 mm with invisible welding seams, safety rounded edges, floor protection in rubber.

1600. NOX
 CESTINO GETTACARTE

WASTE BASKET

Ø 28 x h 35 cm (21 litri)
 Ø 11 x h 13 3/4" (5 1/2 gallons)

1601. NOX
 CESTINO
 CON SUPPORTO PER SACCHETTI

WASTE BASKET
 WITH BAG HOLDER

Ø 28 x h 35 cm (21 litri)
 Ø 11 x h 13 3/4" (5 1/2 gallons)

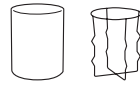
1602. NOX
 CESTINO
 CON SUPPORTO PER SACCHETTI
 E COPERCHIO AD ANELLO

WASTE BASKET
 WITH BAG HOLDER
 AND COVER RING

Ø 28 x 35 cm (21 litri)
 Ø 11 x h 13 3/4" (5 1/2 gallons)

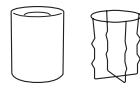
1603. NOX
 CESTINO
 CON SUPPORTO PER SACCHETTI
 E COPERCHIO SPEGNIFIAMMA

WASTE BASKET
 WITH BAG HOLDER
 AND FLAME CHOKING LID

Ø 28 x 35 cm (21 litri)
 Ø 11 x h 13 3/4" (5 1/2 gallons)

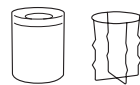
1610. NOX
 PORTAOMBRELLI /
 CESTINO ALTO

UMBRELLA STAND /
 TALL WASTE BASKET

Ø 28 x h 50 (30 litri)
 Ø 11 x h 19 3/4" (8 gallons)

1611. NOX
 CESTINO ALTO CON SUPPORTO
 PER SACCHETTI

TALL WASTE BASKET WITH
 BAG HOLDER

Ø 28 x h 50 (30 litri)
 Ø 11 x h 19 3/4" (8 gallons)

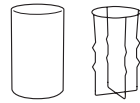
1612. NOX
 CESTINO ALTO CON SUPPORTO
 PER SACCHETTI E COPERCHIO
 AD ANELLO

TALL WASTE BASKET WITH BAG
 HOLDER AND COVER RING

Ø 28 x 50 cm (30 litri)
 Ø 11 x h 19 3/4" (8 gallons)

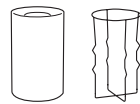

1609. NOX
 CESTINO ALTO CON SUPPORTO
 PER SACCHETTI E COPERCHIO
 SPEGNIFIAMMA

TALL WASTE BASKET WITH BAG
 HOLDER AND FLAME
 CHOKING LID

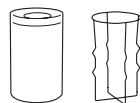
Ø 28 x h 50 (30 litri)
 Ø 11 x h 19 3/4" (8 gallons)

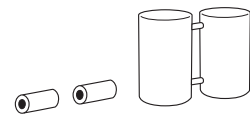

38.
 KIT DI COLLEGAMENTO
 CONNECTION KIT

Ø 3,2 x h 6 cm
 Ø 1 1/4 x h 2 1/2"

1613. NOX
 POSACENERE DA TERRA
 CON CESTINO GETTACARTE

FLOOR ASHTRAY
 WITH WASTE BASKET

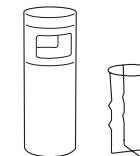
Ø 28 x h 76 (30 litri)
 Ø 11 x h 30" (8 gallons)

1614. NOX
 POSACENERE DA TERRA
 CON CESTINO GETTACARTE

FLOOR ASHTRAY
 WITH WASTE BASKET

Ø 28 x h 76 (30 litri)
 Ø 11 x h 30" (8 gallons)

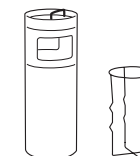
1615. NOX
 POSACENERE DA TERRA
 CON CESTINO GETTACARTE

FLOOR ASHTRAY
 WITH WASTE BASKET

Ø 28 x h 76 (30 litri)
 Ø 11 x h 30" (8 gallons)

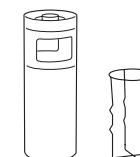
1620. NOX
 POSACENERE DA TERRA
 CON VASCHETTA

FLOOR ASHTRAY
 WITH CUP

Ø 28 x h 76
 Ø 11 x h 30"

1621. NOX
 POSACENERE DA TERRA,
 VASCHETTA CON GRIGLIA

FLOOR ASHTRAY,
 CUP WITH GRID

Ø 28 x h 76
 Ø 11 x h 30"

1622. NOX
 POSACENERE DA TERRA,
 VASCHETTA CON RILIEVO
 E COPERCHIO AD ANELLO

FLOOR ASHTRAY,
 CUP WITH RAISED CENTER
 AND COVER RING

Ø 28 x h 76
 Ø 11 x h 30"

NOX MAGNUM
 design Raul Barbieri



Contentori in acciaio inossidabile AISI 304 0,8 mm satinato con saldatura invisibile, bordi arrotondati antinfortunio, guarnizione salva-pavimento in gomma.

Containers in brushed stainless steel AISI 304 0,8 mm with invisible welding seams, safety rounded edges, floor protection in rubber.

1665. NOX MAGNUM
 CONTENITORE

CONTAINER

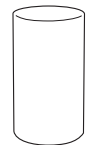
Ø 38 x h 64 cm (70 litri)
 Ø 15 x h 25" (18 1/2 gallons)

1666. NOX MAGNUM
 CONTENITORE
 CON SUPPORTO PER SACCHETTI

CONTAINER WITH BAG HOLDER

Ø 38 x h 64 cm (70 litri)
 Ø 15 x h 25" (18 1/2 gallons)

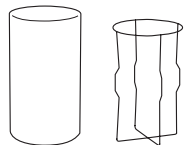
1667. NOX MAGNUM
 CONTENITORE
 CON SUPPORTO PER SACCHETTI E
 ANELLO CON COPERCHIO
 BASCULANTE

CONTAINER
 WITH BAG HOLDER
 AND RING WITH FLIP
 TOP LID

Ø 38 x h 76 cm (70 litri)
 Ø 15 x h 30" (18 1/2 gallons)

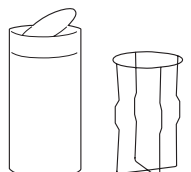

1668. NOX MAGNUM
 CONTENITORE
 CON SUPPORTO PER SACCHETTI
 E COPERCHIO SPEGNIFIAMMA

CONTAINER
 WITH BAG HOLDER
 AND FLAME CHOKING LID

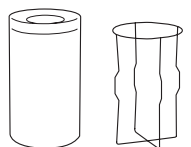
Ø 38 x h 64 cm (70 litri)
 Ø 15 x h 25" (18 1/2 gallons)

38.
 KIT DI COLLEGAMENTO
 CONNECTION KIT

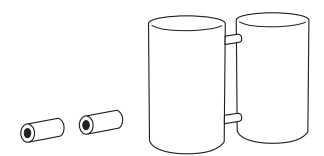
Ø 3,2 x h 6 cm
 Ø 1 1/4 x h 2 1/2"



NOX WALL

design Raul Barbieri



XO

Posacenere e cestini da parete in acciaio inossidabile AISI 304 0,8 mm satinato con bordi arrotondati antinfortunio.

Wall ashtrays and waste baskets in brushed stainless steel AISI 304 0,8 mm with safety rounded edges.

1626. NOX

POSACENERE DA PARETE
CON FISSAGGIO ANTIFURTO

WALL ASHTRAY
WITH ANTI-THEFT FIXING



32 x 16 x h 16 (8 + 8) cm
12 1/2 x 6 1/2 x h 6 1/2 (3 1/4 + 3 1/4)"

1629. NOX WALL

CESTINO DA PARETE
CON FISSAGGIO ANTIFURTO

WALL WASTE BASKET
WITH ANTI-THEFT FIXING



32 x 16 x h 43 (35 + 8) cm (12,5 litri)
12 1/2 x 6 1/2 x h 17 (13 3/4 + 3 1/4)" (3 1/4 gallons)

NOX FLORA

design Raul Barbieri



XO

Fioriere su ruote in acciaio inossidabile AISI 304 0,8 mm satinato con saldatura invisibile e bordi arrotondati antinfortunio.

Planters on castors in brushed stainless steel AISI 304 0,8 mm with invisible welding seams and safety rounded edges.

1681. NOX FLORA

FIORIERE SU RUOTE

PLANTER ON CASTORS

Ø 38 x h 40 (38 + 2) cm
Ø 15 x h 15 3/4 (15 + 3/4)"



1686. NOX FLORA

FIORIERE SU RUOTE

PLANTER ON CASTORS

Ø 52 x h 45 (43 + 2) cm
Ø 20 1/2 x h 17 3/4 (17 + 3/4)"



1688. NOX FLORA

FIORIERE SU RUOTE

PLANTER ON CASTORS

Ø 66 x h 50 (48 + 2) cm
Ø 26 x h 19 3/4 (19 + 3/4)"



NOX VESTA

design Raul Barbieri



XO

Appendiabiti a barra su ruote in acciaio inossidabile AISI 304 satinato.

Coat rails on castors in brushed stainless steel AISI 304.

1640. NOX VESTA

APPENDIABITI A BARRA SU RUOTE

COAT RAIL ON CASTORS

1640.12.
128 (120+8) x 53 x h 170 cm
50 1/2 (47 1/4 + 3 1/4) x 20 3/4 x h 67 "

1640.16.
168 (160+8) x 53 x h 170 cm
66 1/4 (63 + 3 1/4) x 20 3/4 x h 67 "

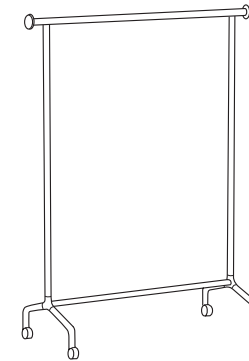

1642. NOX VESTA

APPENDIABITI A BARRA SU RUOTE
CON SUPPORTO PER BORSE

COAT RAIL ON CASTORS
WITH BAG RACK

1642.12.
128 (120+8) x 53 x h 170 cm
50 1/2 (47 1/4 + 3 1/4) x 20 3/4 x h 67 "

1642.16.
168 (160+8) x 53 x h 170 cm
66 1/4 (63 + 3 1/4) x 20 3/4 x h 67 "

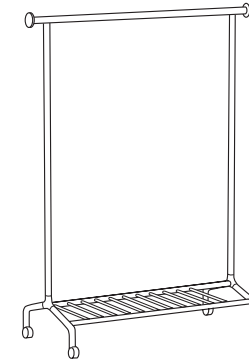

1641. NOX VESTA

APPENDIABITI A BARRA SU RUOTE
CON CAPPELLIERA

COAT RAIL ON CASTORS
WITH HAT RACK

1641.12.
120 x 53 x h 176 cm
47 1/4 x 20 3/4 x h 69 3/4 "

1641.16.
160 x 53 x h 176 cm
63 x 20 3/4 x h 69 3/4 "

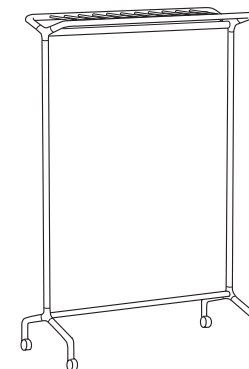

1643. NOX VESTA

APPENDIABITI A BARRA SU RUOTE
CON CAPPELLIERA
E SUPPORTO PER BORSE

COAT RAIL ON CASTORS
WITH HAT AND BAG RACKS

1643.12.
120 x 53 x h 176 cm
47 1/4 x 20 3/4 x h 69 3/4 "

1643 .16.
160 x 53 x h 176 cm
63 x 20 3/4 x h 69 3/4 "

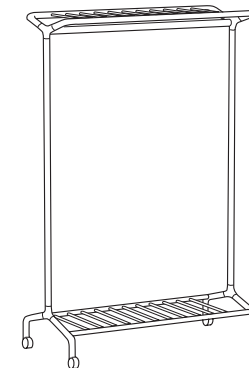

1650. NOX VESTA WALL

APPENDIABITI DA PARETE

WALL COAT RACK

1650.05.
48 x 7 x h 7 cm (3 posti)
19 x 2 3/4 x h 2 3/4" (3 spaces)

1650.10.
96 x 7 x h 7 cm (6 posti)
37 3/4 x 2 3/4 x h 2 3/4" (6 spaces)



1654. NOX VESTA WALL

APPENDIABITI DA PARETE
CON CAPPELLIERA

WALL COAT & HAT RACK

1654.12.
120 x 32 x h 20 cm (7 posti)
47 1/4 x 12 1/2 x h 7 3/4" (7 spaces)

1654.16.
160 x 32 x h 20 cm (9 posti)
63 x 12 1/2 x h 7 3/4" (9 spaces)

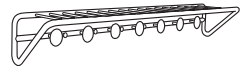

NOX IPSO

design Raul Barbieri



XO

APPENDIABITI DA TERRA
Acciaio inossidabile AISI 304
satinato, guarnizione
salva-pavimento in gomma.

COAT STAND
Brushed stainless steel AISI 304,
floor protection in rubber.

1635. NOX IPSO
Ø 41 x h 170 cm
Ø 16 1/4 x 67 "

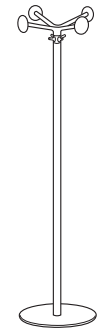

NOX EGO

design Raul Barbieri



XO

APPENDIABITI DA TERRA
Acciaio inossidabile AISI 304
satinato, guarnizione
salva-pavimento in gomma.

COAT STAND
Brushed stainless steel AISI 304,
floor protection in rubber.

1637. NOX EGO
Ø 29 x h 167,5 cm
Ø 11 1/2 x 66 "

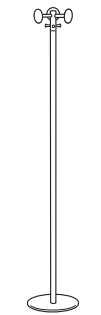

STATUS

design Raul Barbieri

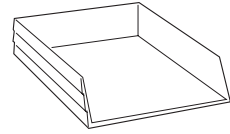
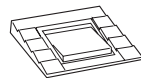
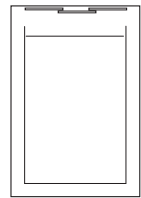
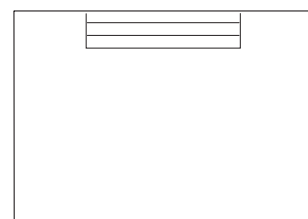
SET DA SCRIVANIA DIREZIONALE
EXECUTIVE DESKTOP SET**350. STATUS**
VASCHETTA
PORTACORRISPONDENZA
Polimero tecnico verniciatoLETTER TRAY
Painted engineering polymer26 x 35 x h 7 cm
10 1/4 x 13 3/4 x h 2 3/4"**332. STATUS**
BICCHIERE PORTAMATITE
Alluminio pressofusoPENCIL CUP
Die-cast aluminiumØ 9 x h 9 cm
Ø 3 1/2 x h 3 1/2"**340. STATUS**
PORTAMEMO
Alluminio pressofusoMEMO PAD HOLDER
Die-cast aluminium15 x 15 x h 2,5 cm
6 x 6 x h 1"**303. STATUS**
SOTTOMANO CON
SEGNAPOSTO
PER TAVOLI CONFERENZE
Poliuretano integraleCONFERENCE DESK PAD
WITH NAME HOLDER
Integral polyurethane28 x 40 x h 1,5 cm
11 x 15 3/4 x h 5/8"**300. STATUS**
SOTTOMANO
Poliuretano integraleDESK PAD
Integral polyurethane70 x 50 x h 0,4 cm
27 1/2 x 19 3/4 x h 1/8"**BABELE**

design Barbieri e Marianelli

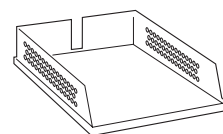
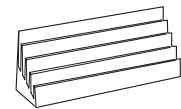
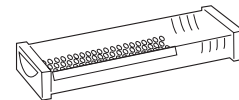
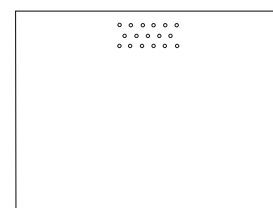
SET DA SCRIVANIA
DESKTOP SET**940. BABELE**
VASCHETTA
PORTACORRISPONDENZA
Polimero tecnicoLETTER TRAY
Engineering polymer25,5 x 35 x h 7 cm
10 x 13 3/4 x h 2 3/4"**921. PODIO**
PORTACARTE
Polimero tecnicoLETTER RACK
Engineering polymer24 x 4,5 x h 9,5 cm
9 1/2 x 1 3/4 x h 3 3/4"**924. SLIM**
VASCHETTA PORTAMATITE
Acciaio, polimero tecnicoPENCIL TRAY
Steel, engineering polymer27,5 x 9 x h 3,5 cm
11 x 3 1/2 x h 1 1/2"**930. CENTOBUCHI**
BICCHIERE PORTAMATITE
Alluminio, polimero tecnicoPENCIL CUP
Aluminium, engineering polymerØ 8 x h 10 cm
Ø 3 x h 4"**944. MEMO**
PORTAMEMO
Polimero tecnicoMEMO PAD HOLDER
Engineering polymer11 x 11 x h 7 cm
4 1/2 x 4 1/2 x h 2 3/4"**904. PLANO**
SOTTOMANO
LinoleumDESK PAD
Linoleum60 x 45 x h 0,3 cm
23 1/2 x 17 3/4 x h 1/8"**STANDARD**

design Julian Brown

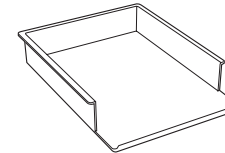
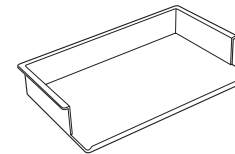
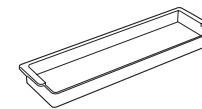
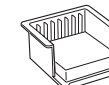
SET DA SCRIVANIA E DA PARETE
DESKTOP AND WALL SET**650. STANDARD**
PORTACORRISPONDENZA
FRONTALE
Polimero tecnicoFRONT LETTER TRAY
Engineering polymer27 x 34,5 x h 6,5 cm
10 1/2 x 13 1/2 x h 2 1/2"**655. STANDARD**
PORTACORRISPONDENZA
LATERALE
Polimero tecnicoSIDE LETTER TRAY
Engineering polymer35,5 x 26 x h 6,5 cm
14 x 10 1/4 x h 2 1/2"**610. STANDARD**
VASCHETTA PORTAMATITE
Polimero tecnicoPENCIL TRAY
Engineering polymer35,5 x 12,5 x h 3,5 cm
15 x 5 x h 1 1/2"**632. STANDARD**
BICCHIERE PORTAMATITE
Polimero tecnicoPENCIL CUP
Engineering polymer9 x 9 x h 9,5 cm
3 1/2 x 3 1/2 x h 3 3/4"**640. STANDARD**
PORTA MEMO
Polimero tecnicoMEMO PAD HOLDER
Engineering polymer12,5 x 12,5 x h 6,5 cm
5 x 5 x h 2 1/2"**MODUS**

design Kuno Prey

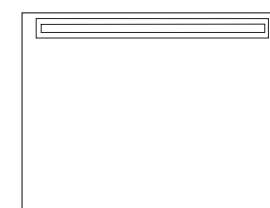
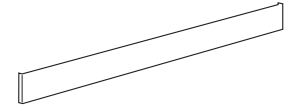
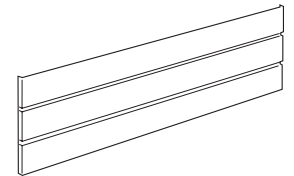
SOTTOMANO CON
VASCHETTA PORTAMATITE
Gomma naturale,
polimero tecnicoDESK PAD WITH
PENCIL TRAY
Natural rubber,
engineering polymer**400. MODUS**
60 x 45 x h 0,6 cm
23 1/2 x 17 3/4 x h 1/4"**STANDARD**
BINARIO DA PARETE
1 LIVELLO
Alluminio anodizzato1 LEVEL WALL BEAM
Anodized aluminium**B080.** 6 x 1 x L 80 cm
2 1/4 x 1/2 x 31 1/2"**B100.** 6 x 1 x L 100 cm
2 1/4 x 1/2 x 39 1/2"**B120.** 6 x 1 x L 120 cm
2 1/4 x 1/2 x 47 1/4"**STANDARD**
BINARIO DA PARETE
3 LIVELLI
Alluminio anodizzato3 LEVELS WALL BEAM
Anodized aluminium**C080.** 20,5 x 1 x L 80 cm
8 x 1/2 x 31 1/2"**C100.** 20,5 x 1 x L 100 cm
8 x 1/2 x 39 1/2"**C120.** 20,5 x 1 x L 120 cm
8 x 1/2 x 47 1/4"

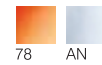
HANNIBAL
design Julian Brown

DISPENSER DI NASTRO ADESIVO
Polimeri tecnici, acciaio

TAPE DISPENSER
Engineering polymers, steel

500. HANNIBAL
80 x 10,5 x h 9,5 cm
3 x 4 x h 3 3/4"

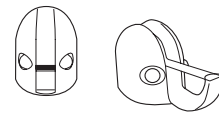
**MULTIPLOR**
design Rino Pirovano

CONTENITORE CON CASSETTI
ROTANTI
Polimero tecnico, acciaio

ROTATING DESK ORGANIZER
Engineering polymer, steel

900. MULTIPLOR
Ø 13 x h 13 cm
Ø 5 x h 5"

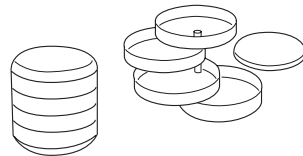
**DUPLO**
design Barbieri e Marianelli

REGGILIBRI
Acciaio

BOOKENDS
Steel

916. DUPLO
14 x 14 x h 20 cm
5 1/2 x 5 1/2 x h 8"

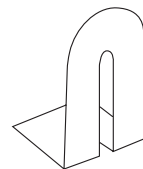
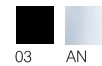
**GEMINI**
design Barbieri e Marianelli

REGGILIBRI
Acciaio

BOOKENDS
Steel

919. GEMINI
15 x 15 x h 20 cm
6 x 6 x h 8"

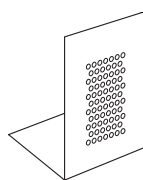
**SAFE TRAY**
design Barbieri e Marianelli

POSACENERE DA TAVOLO
Alluminio, polimero tecnico

TABLE ASHTRAY
Aluminium, engineering polymer

701. SAFETRAY
13 x 13 x h 5 cm
5 x 5 x h 2"

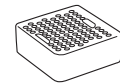
**NOX**
design Raul Barbieri

POSACENERE PER TAVOLI
CONFERENZE
Acciaio inossidabile AISI 304 lucidato

LARGE EXECUTIVE ASHTRAY
Polished stainless steel AISI 304

1690. NOX
Ø 28 x h 5 cm
Ø 11 x h 2"

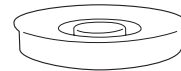
**ORARIO**
design Raul Barbieri

OROLOGIO DA PARETE
Polimeri tecnici

WALL CLOCK
Engineering polymers

986. ORARIO
Ø 45 x 5,5 cm
Ø 17 3/4 x 2 1/4"

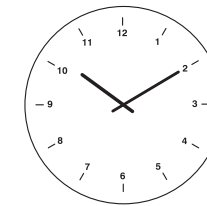
**ORARIO INOX**
design Raul Barbieri

OROLOGIO DA PARETE
Acciaio inossidabile AISI 304

WALL CLOCK
Stainless steel AISI 304

986.XO ORARIO INOX
Ø 45 x 5,5 cm
Ø 17 3/4 x 2 1/4"

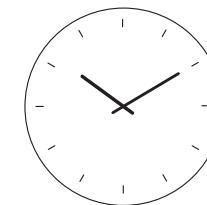
**CONTRATTEMPO**
design Barbieri e Marianelli

OROLOGIO A PENDOLO
DA PARETE
Polimeri tecnici

PENDULUM WALL CLOCK
Engineering polymers

987. CONTRATTEMPO
Ø 45 x 5,5 cm
Ø 17 3/4 x 2 1/4"

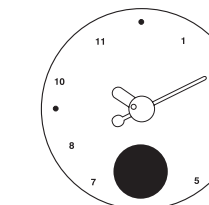
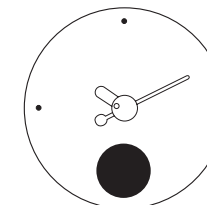
**APPUNTAMENTO**
design Raul Barbieri

OROLOGIO A PENDOLO
DA PARETE
Polimeri tecnici

PENDULUM WALL CLOCK
Engineering polymers

988. APPUNTAMENTO
Ø 45 x 5,5 cm
Ø 17 3/4 x 2 1/4"

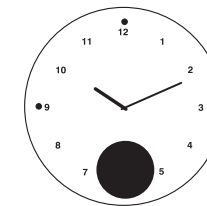
**ZERO**
design Barbieri e Marianelli

OROLOGIO DA PARETE
Polimeri tecnici, vetro in acrilico

WALL CLOCK
Engineering polymers, acrylic glass

980. ZERO
Ø 32 x 5 cm
Ø 12 1/2 x 2"

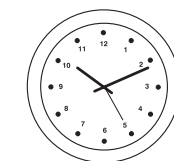

COLORI SOLIDI / SOLID COLOURS



01 bianco white

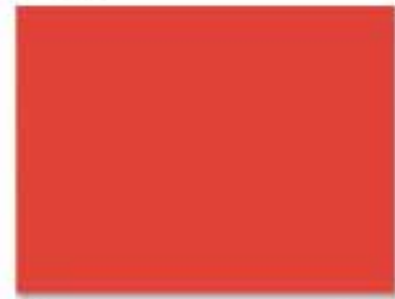

02 rosso red



03 nero black



Y9 sabbia sand



Z5 verde green



Z6 azzurro light blue



06 blu blue



07 grigio grey



08 arancio orange



Z8 lavanda lavender



Z9 castoro beaver



Y2 bordeaux bordeaux



Y3 antracite anthracite

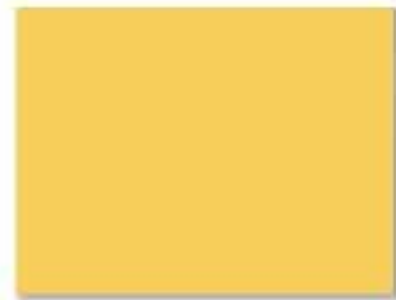

Y4 giallo yellow



03.ST nero soft touch black soft touch

VERNICI / PAINTINGS



Y5 verde oliva olive green



Y6 azzurro chiaro very light blue



Y7 grigio chiaro light grey



AN alluminio aluminium



GD gold gold



SV silver silver

COLORI TRASPARENTI / TRANSPARENT COLOURS

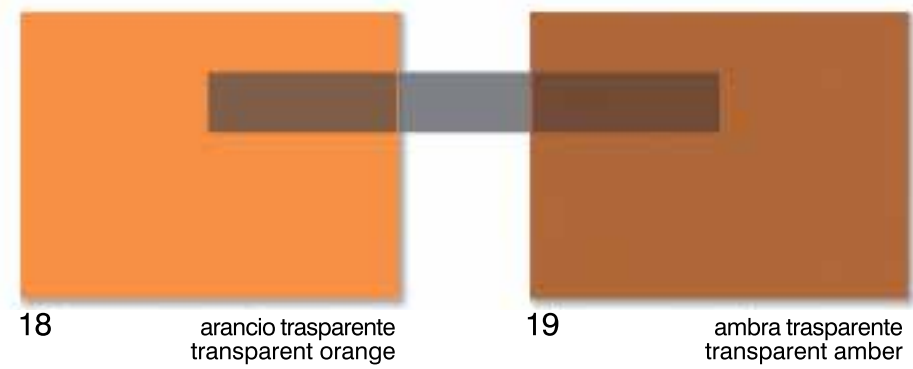
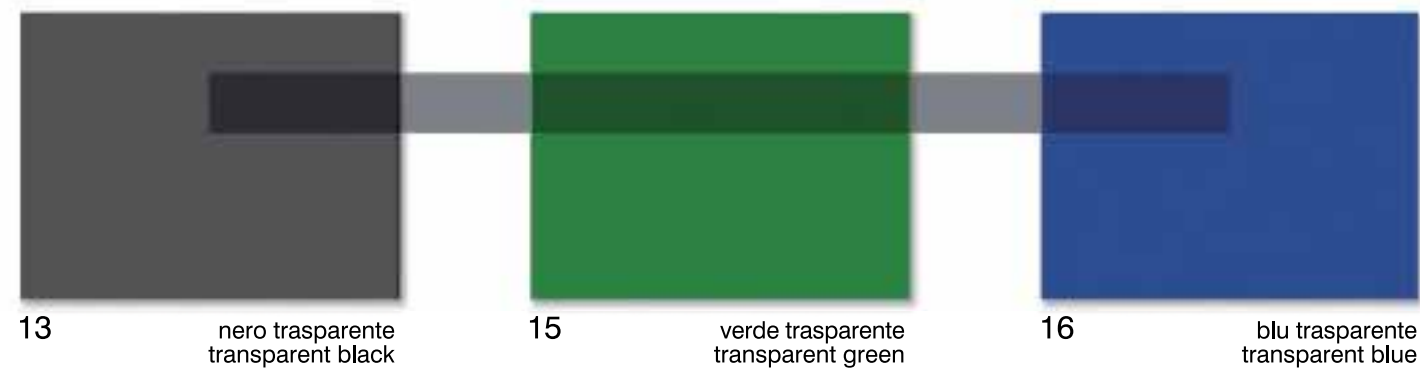
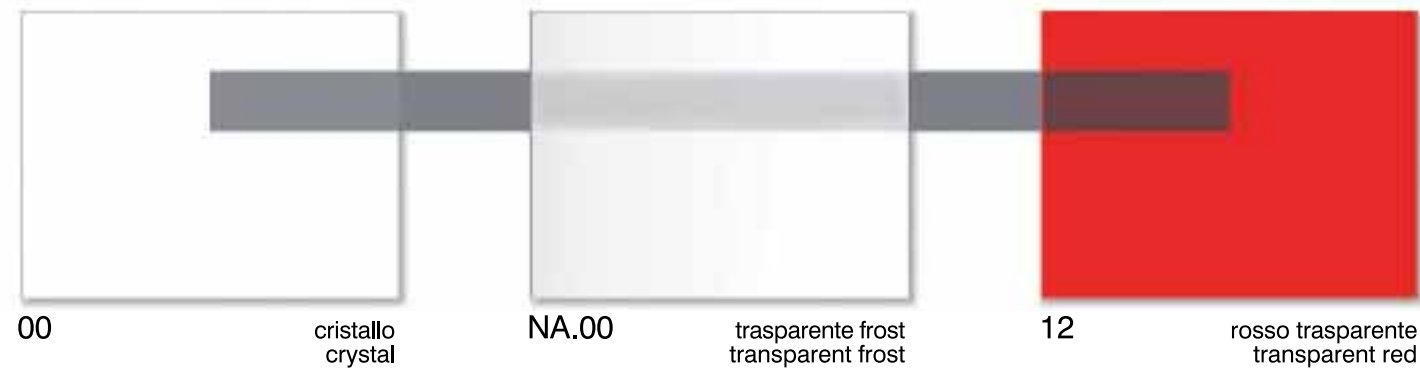

COLORI TRANSLUCIDI / TRANSLUCENT COLOURS

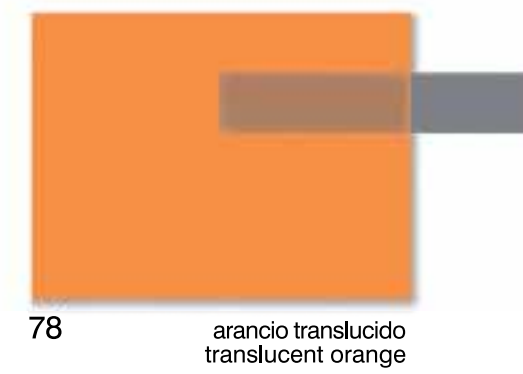
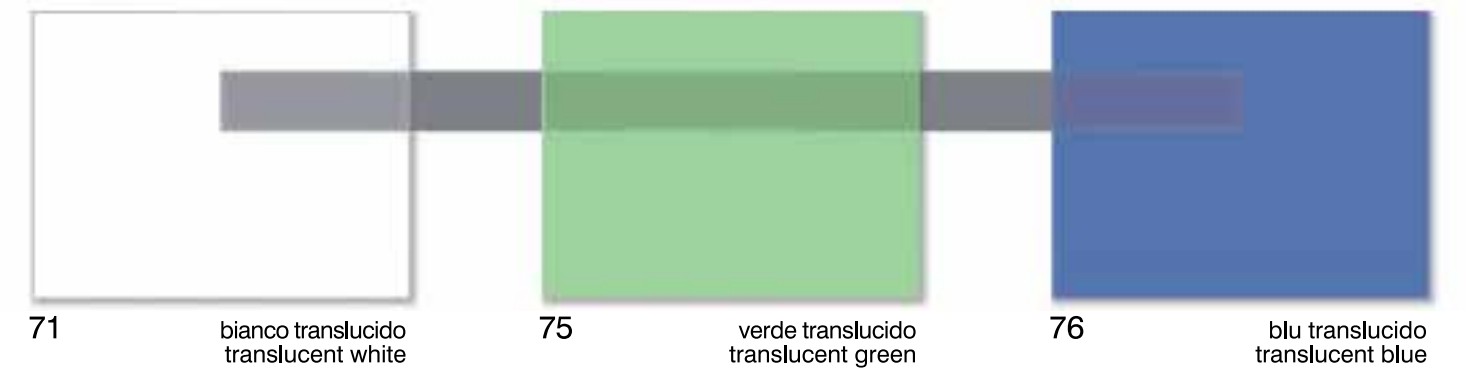

METACRILATO BOOX
METHACRYLATE BOOX

COLORI SOLIDI / SOLID COLOURS

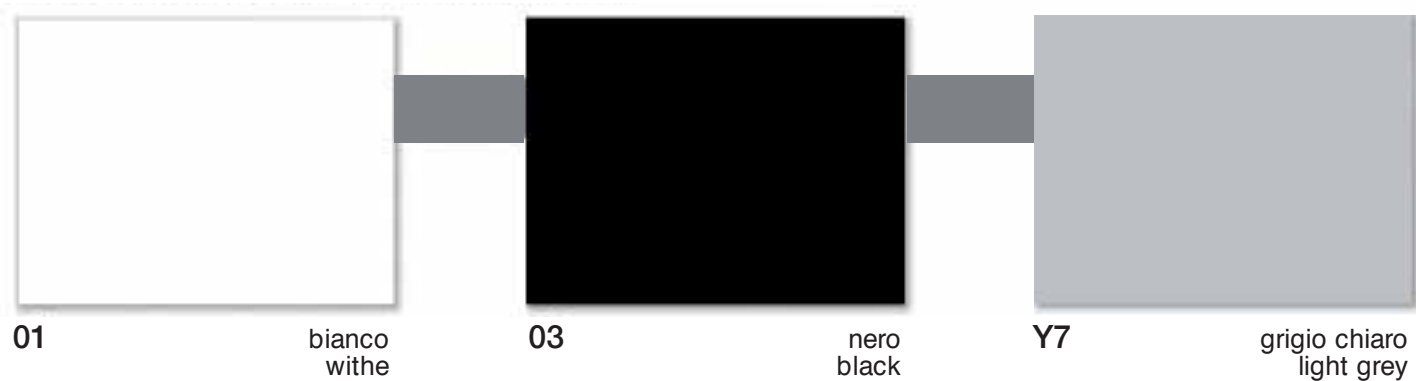

COLORI TRASPARENTI / TRANSPARENT COLOURS

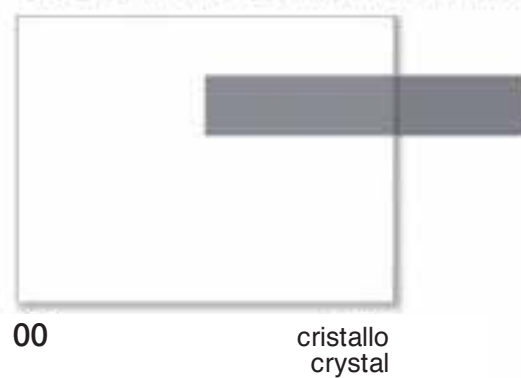

COLORI FROST / FROST COLOURS

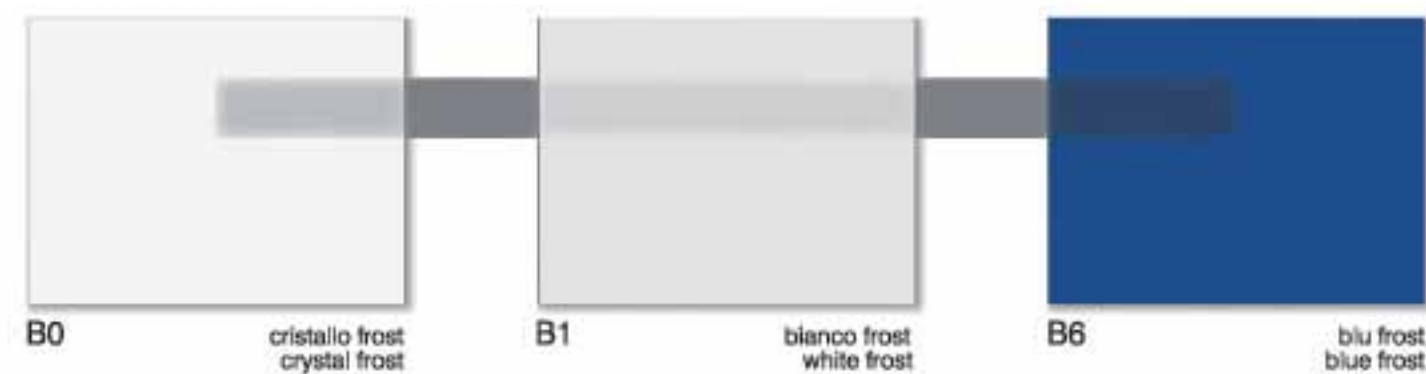

COLORI TRANSLUCIDI / TRANSLUCENT COLOURS

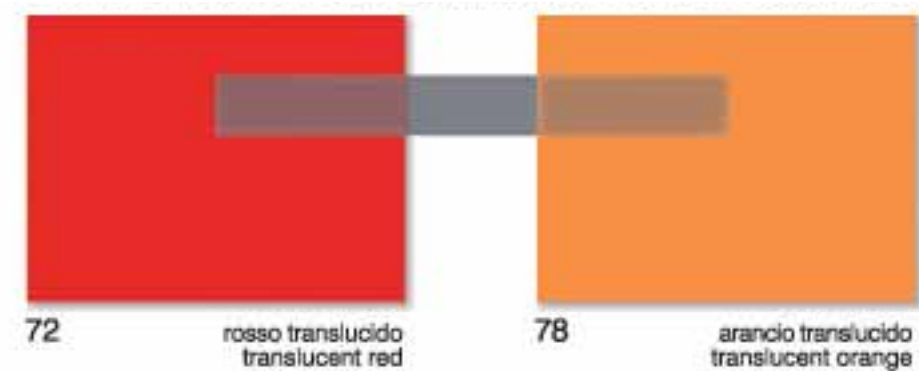

HPL



Z1 bianco white

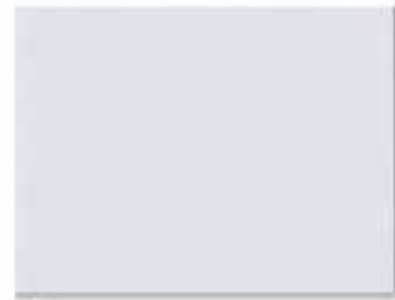

H1 ghiaccio off-white



H2 rosso red



H7 grigio grey

LAMINATO / LAMINATE



L1 bianco white



L3 nero black

VETRO / GLASS



GT trasparente transparent



GS opaco matt



G1 bianco white

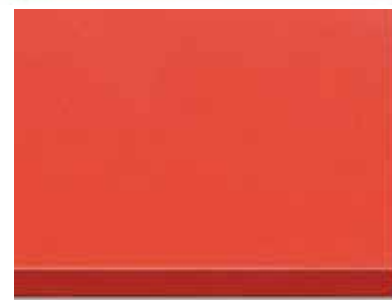

G2 rosso red



G3 nero black



GA alluminio aluminium

METALLO FINITURE / METAL FINISHING



SV silver verniciato antiraffio scratch-resistant painted



AL lucidato polished



CM cromato chromium plated



XO acciaio inox satinato brushed stainless steel

CUOIO / LEATHER

C1

bianco
white

C3

nero
black

C9

testa di moro
dark brown**SIMILPELLE / SYNTHETIC LEATHER**

E1

bianco
white

E3

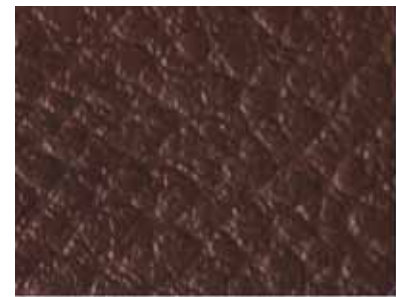
nero
black

E9

testa di moro
dark brown**AVVERTENZE**

I colori delle schede tecniche sono da considerarsi puramente indicativi, non essendo possibile riprodurre fedelmente in stampa le caratteristiche cromatiche dei vari materiali.

ATTENTION

The colours shown on the technical cards are just an example, as it is not possible to reproduce accurately in print the chromatic characteristics of the various materials.

PRECAUTIONS

Les couleurs des fiches techniques doivent être considérées simplement indicatives n'étant pas possible de reproduire fidèlement en imprimerie les caractéristiques chromatiques des différents matériaux.

ANMERKUNGEN

Die Musterfarben der Produktdatenblätter sind nur als Anhalt gedacht, da es nicht möglich ist, die chromatischen Eigenschaften der verschiedenen Stoffe wahrheitsgetreu abzubilden

AVISO

Los colores de las fichas técnicas se deben considerar puramente indicativos, no siendo posible reproducir fielmente en la impresión las características cromáticas de los diversos materiales.

REFERENCES

| ABA Bank + Abitare + Agfa Gevaert
 + Arthur Andersen + Assicurazioni
 Generali + Assolombarda + Audi +
 Autogrill + AXA Assicurazioni + Banca
 Agricola Mantovana + Banca d' Italia +
 Banca di Roma + Banca Fideuram +
 Banca Indo Suez + Bancaintesa +
 Banca Nazionale del Lavoro + Banca
 Popolare di Lodi + Bayer + BLU + BMW
 + Bonaparte Hotel + Canol + Cisco +
 Citibank + Coca-Cola + Comando
 Aeronautica Militare + Commerzbank +
 Compaq + Credit Suisse + Credito
 Emiliano + De Longhi + Deutsche
 Bank + Digital + e-Biscom + Edisontel
 + Eptaconsors + Europe Assistance
 + Ferservizi + FIAT + Fideuram + Fiera
 Milano + Fila + Fininvest + Forte Hotel
 Group + Gemeaz Cusin + General
 Electric + Hotel Ibis + Hyundai +
 IBM + I.C.E. + Icon Medialab + Illva
 + Jolly Hotels + Laguna Palace Hotel
 + Lottomatica + Max Mara + Mediaset +
 Mediolanum + Mercedes-Benz + MGE
 UPS System + Ministero della Difesa +
 Ministero delle Finanze + Mobil Oil
 + Mondadori + Monte Paschi Siena
 + Montell + NCR + Nestle + Poste
 Italiane + RAS Bank + RTL + Siemens
 + Snai + Sogei + Star Hotels + ST
 Microelectronics + Telecom + Toro
 Assicurazioni + Trane Italia + Trenitalia
 + Triennale di Milano + UBS + Una
 Hotels + Unicredit + Universita Bicocca
 + Universita Bocconi + Veneto Banca
 + Vodafone Omnitel + Volkswagen
 + Zucchetti Informatica **A**
 Fachhochschule Steyr + Hypo Bank +
 Infineon Technologies + Lambers +
 Siemens VDO Automotive + Uniqa Tower
 Versicherungen AG **AUS** Vodafone
B Cargill Cerestar + Ministerie Van de
 Vlaamse Gemeenschap + Ministerie
 de la Region Wallone + Parlement



Wallone + Supermarche Cactus + UCB
CH BMW + Credit Swiss + Deutsche
 Bank + Mercedes-Benz + MontBlanc
 + Nestle + Schweizer + Rueck + Swiss
 Re + Telecom **D** Accor Hotellerie D
 + Audi + BMW + Bosch + CC - Bank
 + Commerzbank + Deimler Chrysler +
 Deutsche Bank + Deutsche Telekom +
 Dresdner Bank + Eurohypo Bank +
 Festo + Hypo Bank + Lufthansa
 + Mc Donald's + Mercedes-AMG +
 Meridien Hotels + Reiffeisenbank
 + Siemens + Telecom Vodafone D2 +
 Volksbank + Volkswagen Bank
E El Divino - IBIZA + Mercedes-Benz
 + SANITAS + Telecom **EI** A-L
 GOODBODY + Anglo Irish Bank **F**
 Accor Hotels + Aquavita + Arthur
 Andersen + Centre Georges Pompidou
 + Credit Lyonnais + Credit Mutuel +
 Hugo Boss + IBM + Louis Vuitton +
 Meridien Hotels + Ministere de la Culture
 + Ministere des Affaires Etrangeres +
 Olivarius Appart'Hotel + SFR + Societe
 Generale + Stas Doyer + YAMAHA
MEX Telecom **NL** Belastingdiensten
 + ING Bank + Interpolis + Ministerie van
 Justitie + Philips + Royal Numico +
 Telecom + UWW **SF** Nokia
UK Abbey Bank + ABN + AMRO +
 Bank of Scotland + Cumberland Hotel +
 Deutsche Bank + Eastpoints Exhibitions
 + Essex County Council + Fidelity
 Investments + Invesco Ltd. + Meridien
 Hotels + Michael Sheridan + Procter &
 Gamble + Standard Chartered Bank +
 100% Design **USA** Arthur Andersen
 + Bell South + BMW + Chicago
 University + Chicago Children's Hospital
 + Coca-Cola + Deloitte Touche +
 Guggenheim Museum N.Y. + IOWA State
 University + IOWA City Public Library +
 Seattle Courthouse + Seattle Polyclinic
 + Swiss Re + Wells Fargo.

CONCEPT
Raul Barbieri

PROJECT AND LAYOUT
Reclame

ART DIRECTOR
Raul Barbieri

STYLING
Gabriella Montaguti

PRINT
Centro Stampa
Milano Ovest